

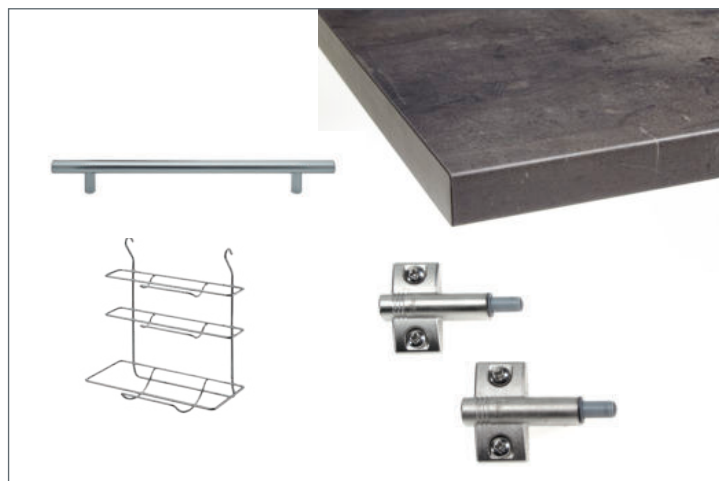







**Zubehör / accessories / accessories / accessories**

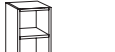

## Farbige Regale

coloured shelves / gekleurde schappen / étagères colorées

	Maße dimension afmetingen dimensions	B = Breite / width / breedte / largeur cm H = Höhe / height / hoogte / hauteur cm T = Tiefe / depth / diepte / profondeur cm				B = Breite	Artikel-Nr. article-no. artikel nr. article n°.	Identnr./ID no./ID-nr./no.-ID  Y10
		DE	EN	NL	FR			
	H = 19,2 cm T = 34,6 cm	Oberschrankregal	wall unit storage shelf	hangkasten rek	étagère murale	40,0	OR419+	
						50,0	OR519+	
						60,0	OR619+	
	H = 32,0 cm T = 34,6 cm	Oberschrankregal	wall unit storage shelf	hangkasten rek	étagère murale	40,0	OR432+	
						50,0	OR532+	
	H = 35,2 cm T = 34,6 cm	Oberschrankregal	wall unit storage shelf	hangkasten rek	étagère murale	30,0	OR335+	nicht in Anthrazit erhältlich not available in anthracite niet leverbaar in antraciet non disponible en anthracite
	H = 35,2 cm T = 34,6 cm	Oberschrankregal	wall unit storage shelf	hangkasten rek	étagère murale	30,0	OR357+	
		1 Glaseinlegeboden	1 glass shelf	1 glazen plank	1 étagère en verre	40,0	OR457+	
						50,0	OR557+	
	H = 44,4 cm T = 34,6 cm	Oberschrankregal	wall unit storage shelf	hangkasten rek	étagère murale	150,0	SR1550+	nicht in Anthrazit erhältlich not available in anthracite niet leverbaar in antraciet non disponible en anthracite
		1 Schiebeelem. 50 cm 1 Glaseinlegeboden 2 Designstangen in Edelstahl-Optik	1 sliding door 50 cm 1 glass shelf 2 designposts in stainless-steel optic	1 schuifdeur 50 cm 1 glazen plank 2 designposten in roestvrijstalen optiek	1 porte coulissante 50 cm 1 étagère en verre 2 tiges de design en optique en acier inoxydable.			
	H = 44,4 cm T = 34,6 cm	Oberschrankregal	wall unit storage shelf	hangkasten rek	étagère murale	150,0	SR1575+	
		1 Schiebeelement 75 cm	1 sliding door panel 75 cm	1 schuifdeur 75 cm	1 porte coulissante 75 cm			
	H = 82,0 cm T = 34,6 cm	Unterschrank-/ Oberschrankregal	base unit / wall unit storage	hangkasten / onderkasten rek	étagère murale / bas	30,0	UR382+	nicht in Anthrazit erhältlich not available in anthracite niet leverbaar in antraciet non disponible en anthracite
		2 Z-Böden ohne Arbeitsplatte	2 mounted shelves without worktop	2 legplanken zonder werkblad	2 étagères montées sans plan de travail			
	H = 86,8 cm T = 13,6 cm	Rückwandpaneel	wall panel with storage shelves	wandpaneel met rek	panneau mural	50,0	RP587+	nicht in Anthrazit erhältlich not available in anthracite niet leverbaar in antraciet non disponible en anthracite
		2 Ablageböden	2 shelves	2 planken	2 étagères			

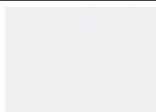

RWE  
Weiß  
white  
wit  
blanc

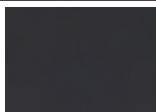

RAN\*  
Anthrazit  
anthracite  
antraciet  
anthracite



REI  
Eiche-hell sägerau Nachb.  
light oak decor  
licht eiken decor  
décor chêne clair

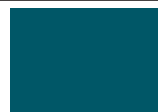

ROP  
Opal  
opal green  
opaalgroen  
opale verte



RRO  
Rot  
red  
rood  
rouge



RAK  
Akazie Nachbildung  
acacia decor  
akazia decor  
décor acacia clair

## Oberschränke mit Glasrahmentür in Alu-Optik

wall units with framed glass doors in aluminium-optics/ hangkasten met ingelijste glazen deuren in aluminium kleur/ éléments murale avec portes en verre encadrées en aspect aluminium

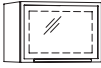
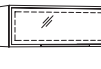
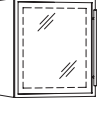
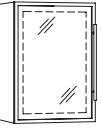
	Maße dimension afmetingen dimensions	B = Breite / width / breedte / largeur cm H = Höhe / height / hoogte / hauteur cm T = Tiefe / depth / diepte / profondeur cm				Artikel-Nr. article-no. artikel nr. article n°.	Identnr./ID no./ID-nr./no.-ID Y10
		DE	EN	NL	FR		
	H = 35,2 cm T = 35,2 cm	Oberschrank mit Glasrahmenklappe in Alu-Optik	wall unit with aluminium-colour framed glass flap	hangkast met aluminium-umkleurige ingelijste glasklep	élément murale avec volet en verre encadré de couleur aluminium	50,0	OKA535
		1x Stangengriff in Edelstahl-Optik	1x handle bar in stainless steel optics	1x duwstang in roestvrijstalen optiek	1x poignée en optique inox	60,0	OKA635
	H = 35,2 cm T = 35,2 cm	Oberschrank mit Glasrahmenklappe in Alu-Optik	wall unit with aluminium-colour framed glass flap	hangkast met aluminium-umkleurige ingelijste glasklep	élément murale avec volet en verre encadré de couleur aluminium	80,0	OKA835
		1x Stangengriff in Edelstahl-Optik	1x handle bar in stainless steel optics	1x duwstang in roestvrijstalen optiek	1x poignée en optique inox	90,0	OKA935
						100,0	OKA135
	H = 57,6 cm T = 35,2 cm	Oberschrank mit Glasrahmentür in Alu-Optik	wall unit with aluminium-colour framed glass door	hangkast met aluminium-umkleurige ingelijste glasklep	élément murale avec volet en verre encadré de couleur aluminium	50,0	OA506
		1x Stangengriff in Edelstahl-Optik 1x Einlegeboden	1x handle bar in stainless steel optics 1x shelf	1x duwstang in roestvrijstalen optiek 1x plank	1x poignée en optique inox 1x étagère	60,0	OA606
	H = 70,4 cm T = 35,2 cm	Oberschrank mit Glasrahmentür in Alu-Optik	wall unit with aluminium-colour framed glass door	hangkast met aluminium-umkleurige ingelijste glasklep	élément murale avec volet en verre encadré de couleur aluminium	50,0	OMA506
		1x Stangengriff in Edelstahl-Optik 2x Einlegeboden	1x handle bar in stainless steel optics 2x shelves	1x duwstang in roestvrijstalen optiek 2x planken	1x poignée en optique inox 2x étagères	60,0	OMA606



Satiniertes Glas  
Korpusfarbe weiß  
inkl. Stangengriff

satined glass  
carcase colour white  
incl. handle bar

gesatineerd glas  
corpus kleur wit  
incl. duwstang

verre satiné  
couleur du caisson  
blanc poignée incluse

















## Zubehör push-to-open für Oberschränke

accessories push-to-open wall units / accessoires push-to-open hangkasten / accessoires push-to-open élément murale

	Maße dimension afmetingen dimensions	B = Breite / width / breedte / largeur cm H = Höhe / height / hoogte / hauteur cm T = Tiefe / depth / diepte / profondeur cm				Artikel-Nr. article-no. artikel nr. article n°.	Identnr./ID no./ID-nr./no.-ID Y10
		DE	EN	NL	FR		
		Push-to-open Mechanik 1 Stück	push-to-open mechanism 1 piece	push-to-open mechanism 1 stuk	push-to-open mécanisme 1 pièce	PTO	

## Griffe Metall





handles metal / grepen metalen / poignées métalliques

Maße dimension afmetingen dimensions	B = Breite / width / breedte / largeur cm H = Höhe / height / hoogte / hauteur cm T = Tiefe / depth / diepte / profondeur cm	L = Länge / length / lengte / longueur cm				L = Länge	Artikel-Nr. article-no. artikel nr. article n°.	Identnr./ID no./ID-nr./no.-ID  Y10
		DE	EN	NL	FR			
	128 mm	Metall Edelstahl-Optik, gebürstet 2 Stück / Pack	metal stainless steel optic, brushed 2 pieces / pack	metaal in roestvrij staal look 2 stuks / verpakking	métal en aspect acier inoxydable 2 pièces / paquet	19,2	G021	
	128 mm	Aluminium schwarz matt 2 Stück / Pack	aluminium mat black 2 pieces / pack	aluminium zwart mat 2 stuks / verpakking	aluminium noir mat 2 pièces / paquet	16,3	G463	
	128 mm	Zamak in Nickel-Optik gebürstet 2 Stück / Pack	zamak nickel optics, brushed 2 pieces / pack	geborsteld nikkel-look zamac 2 stuks / verpakking	zamac brossé aspect nickel 2 pièces / paquet	13,7	G495	
	128 mm	Aluminium Edelstahl-Optik, gebürstet 2 Stück / Pack	aluminium stainless steel optic, brushed 2 pieces / pack	aluminium roestvrij staal look, geborsteld 2 stuks / verpakking	aluminium Aspect acier inoxydable, brossé 2 pièces / paquet	13,7	G500	
	192 mm	Zamak in Nickel-Optik gebürstet 2 Stück / Pack	zamak nickel optics, brushed 2 pieces / pack	geborsteld nikkel-look zamac 2 stuks / verpakking	zamac brossé aspect nickel 2 pièces / paquet	20,5	G603	
	128 mm	Aluminium Edelstahl-Optik, gebürstet 2 Stück / Pack	aluminium stainless steel optic, brushed 2 pieces / pack	aluminium roestvrij staal look, geborsteld 2 stuks / verpakking	aluminium Aspect acier inoxydable, brossé 2 pièces / paquet	16,0	G620	
	128 mm	Aluminium Edelstahl-Optik, gebürstet 2 Stück / Pack	aluminium stainless steel optic, brushed 2 pieces / pack	aluminium roestvrij staal look, geborsteld 2 stuks / verpakking	aluminium Aspect acier inoxydable, brossé 2 pièces / paquet	25,7	G621	
	2x 128 mm	Aluminium Edelstahl-Optik, gebürstet 2 Stück / Pack	aluminium stainless steel optic, brushed 2 pieces / pack	aluminium roestvrij staal look, geborsteld 2 stuks / verpakking	aluminium Aspect acier inoxydable, brossé 2 pièces / paquet	44,8	G622	
	192 mm	Griffleiste Aluminium eloxiert 2 Stück / Pack	handle bar aluminium anodised 2 pieces / pack	geanodiseerde aluminium greeplijst 2 stuks / verpakking	bande de poignée en aluminium anodisé 2 pièces / paquet	23,0	G623	
	128 mm	Zamak schwarz matt 2 Stück / Pack	zamak mat black 2 pieces / pack	zamak zwart mat 2 stuks / verpakking	zamac noir mat 2 pièces / paquet	14,2	G625	
	192 mm	Metall Edelstahl-Optik, gebürstet 2 Stück / Pack	metal stainless steel optic, brushed 2 pieces / pack	metaal in roestvrij staal look 2 stuks / verpakking	métal en aspect acier inoxydable 2 pièces / paquet	25,6	G700	
	256 mm	Metall Edelstahl-Optik, gebürstet 2 Stück / Pack	metal stainless steel optic, brushed 2 pieces / pack	metaal in roestvrij staal look 2 stuks / verpakking	métal en aspect acier inoxydable 2 pièces / paquet	32,0	G701	
	352 mm	Metall Edelstahl-Optik, gebürstet 2 Stück / Pack	metal stainless steel optic, brushed 2 pieces / pack	metaal in roestvrij staal look 2 stuks / verpakking	métal en aspect acier inoxydable 2 pièces / paquet	41,6	G702	
	448 mm	Metall Edelstahl-Optik, gebürstet 2 Stück / Pack	metal stainless steel optic, brushed 2 pieces / pack	metaal in roestvrij staal look 2 stuks / verpakking	métal en aspect acier inoxydable 2 pièces / paquet	51,2	G703	
	544 mm	Metall Edelstahl-Optik, gebürstet 2 Stück / Pack	metal stainless steel optic, brushed 2 pieces / pack	metaal in roestvrij staal look 2 stuks / verpakking	métal en aspect acier inoxydable 2 pièces / paquet	60,8	G704	
	704 mm	Metall Edelstahl-Optik, gebürstet 2 Stück / Pack	metal stainless steel optic, brushed 2 pieces / pack	metaal in roestvrij staal look 2 stuks / verpakking	métal en aspect acier inoxydable 2 pièces / paquet	76,8	G705	
	160 mm	Metall Edelstahl-Optik, gebürstet 2 Stück / Pack	metal stainless steel optic, brushed 2 pieces / pack	metaal in roestvrij staal look 2 stuks / verpakking	métal en aspect acier inoxydable 2 pièces / paquet	17,9	G733	

# Zubehör / accessories / accessories / accessories





## Griffe

handles / grepen / poignées









	Bohrabstand drilling distance boorafstand distance de forage	B = Breite / width / breedte / largeur cm H = Höhe / height / hoogte / hauteur cm T = Tiefe / depth / diepte / profondeur cm				L = Länge L = Länge	Artikel-Nr. article-no. artikel nr. article n°.	Identnr./ID no./ID-nr./no.-ID Y10
		DE	EN	NL	FR			
		Zamak in Nickel-Optik gebürstet 2 Stück / Pack	zamac nickel optics, brushed 2 pieces / pack	geborsteld nikkel-look zamac 2 stuks / verpakking	zamac brossé aspect nickel 2 pièces / paquet	2,67	G639	
		Zamak in Nickel-Optik gebürstet 2 Stück / Pack	zamac nickel optics, brushed 2 pieces / pack	geborsteld nikkel-look zamac 2 stuks / verpakking	zamac brossé aspect nickel 2 pièces / paquet	3,51	G640	
		Griffleiste Metall Edelstahl-Optik, gebürstet	handle bar metal stainless steel optic, brushed	stuurstang metaal in roestvrij staal look	barre de préhension métal en aspect acier inoxydable	29,6	G710	
						39,6	G711	
						44,6	G712	
						49,6	G713	
						59,6	G714	
						89,6	G715	
34,6	G716							
		Markierhilfe/Ankörnhilfe für Grifflochbohrungen	marking aid template for handle drillings	markeringshulpjabloon voor handgreepbo- ringen	gabarit d'aide au marquage pour les perçages de poignées	34,5	BSCHABLONE	

## Griffe Kunststoff

handles plastic / grepen kunststof / poignées en plastique

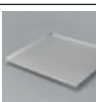





	Bohrabstand drilling distance boorafstand distance de forage	B = Breite / width / breedte / largeur cm H = Höhe / height / hoogte / hauteur cm T = Tiefe / depth / diepte / profondeur cm				L = Länge L = Länge	Artikel-Nr. article-no. artikel nr. article n°.	Identnr./ID no./ID-nr./no.-ID Y10
		DE	EN	NL	FR			
	128 mm	Kunststoff in Alu-Optik	plastic, aluminium optics	kunststof in aluminium- look	le plastique à l'aspect aluminium	16,36	G418	
	128 mm	Kunststoff, Bronze-grau 2 Stück / Pack	plastic bronze grey 2 pieces / pack	kunststof bronzen grijs 2 stuks / verpakking	matière plastique, gris bronze 2 pièces / paquet	14,34	G472	
	96 mm	Kunststoff, Silber-grau 2 Stück / Pack	plastic silvergrey 2 pieces / pack	kunststof zilver grijs 2 stuks / verpakking	matière plastique, gris argent 2 pièces / paquet	10,69	G530	
	96 mm	Kunststoff, Weiß 2 Stück / Pack	plastic white 2 pieces / pack	kunststof wit 2 stuks / verpakking	matière plastique blanc 2 pièces / paquet	10,59	G851	

# Zubehör / accessories / accessories / accessories

Maße dimension afmetingen dimensions	B = Breite / width / breedte / largeur cm H = Höhe / height / hoogte / hauteur cm T = Tiefe / depth / diepte / profondeur cm				Artikel-Nr. article-no. artikel nr. article n°.	Identnr./ID no./ID-nr./no.-ID		
	DE	EN	NL	FR			Y10	
		Relingsystem	railing system	railing systeem	système de garde-corps	120,0	RS	
		Papierrollenhalter verchromt	paper roll holder chrome	verchromde toile- trouhouder	porte-papier toilette chromé		ZT891	
		Dämpfungssystem für Türen  für Clipscharnier je 2 Stück / Pack Bestelleinheit 10 Stück	damping-system for doors  for clip hinge 2 pcs / unit order unit 10 pieces	dempingssysteem voor deuren  voor clipscharnier 2 stuks / eenheid besteleenheid 10 stuks	système de l'atténuation pour portes pour charnière à clip 2 pcs / unité commande unité 10 pièces		BLU-MT2	
		Dämpfungssystem für Türen je 2x Stück / Pack für 1x Tür = 1x Stück  Bestelleinheit 10 Stück	damping-system for doors 2x pcs / unit for 1x door = 1x piece order unit 10 pieces	dempingssysteem voor deuren elk 2x per stuk / verpakking voor 1x deur = 1x stuk besteleenheid 10 stuks	système d'amortissement pour les portes chaque 2x pièce / paquet pour 1x porte = 1x pièce unité de commande 10 pièces		BLU232	
	H = 7,4 cm	Sockel-Lüftungsgitter Kunststoff Aluminium Optik, 50 cm breit	base ventilation grille plastic aluminium optic, 50 cm wide	sokkel ventilatierooster kunststof, aluminium look, 50 cm breed	base grille de ventilation en plastique, aspect aluminium, largeur 50 cm	46,9	LG	
	T = 50,1 cm	Tropfschutzblech Einlegeblech Aluminium	drip protection panel inner panel aluminium	lekbak insteekplaat aluminium	plateau d'égouttage plaque d'insertion aluminium	46,6	SBB50-8	
						56,6	SBB60-8	
						86,6	SBB90-8	
						96,6	SBB100-8	
	H = 2,5 cm	Montageschiene  zur Aufhängung von Oberschränken  Bestelleinheit 10 Stück	mounting rail  for suspension of wall units order unit 10 piece	montagerail  voor hangende boven- kasten besteleenheid 10 stuks	rail de montage  pour suspendre des éléments hauts unité de commande 10 pièces	210,0	MS210-8	
	T = 28,4 cm	Glaseinlegeboden 2 Stück, ESG	glass shelf 2 pieces	glazen plank 2 stukken	étagère en verre 2 pièces	46,2	GBESG50-8	
Maße dimension afmetingen dimensions	B = Breite / width / breedte / largeur cm H = Höhe / height / hoogte / hauteur cm T = Tiefe / depth / diepte / profondeur cm				Artikel-Nr. article-no. artikel nr. article n°.	Identnr./ID no./ID-nr./no.-ID		
	DE	EN	NL	FR			Y10	
	H = 2,0 cm T = 1,5 cm	LED-Unterbauleuchte 5,8 Watt, 6000 Kelvin, 320 Lumen, 230 Volt, 1 mtr. Zuleitung inkl. Schalter  Dieses Produkt enthält eine Lichtquelle der Energieeffi- zienzklasse F	LED under-cabinet light 5.8 watts, 6000 Kelvin, 320 lumens, 230 volts, 1 mtr. supply including switch  This product contains a light source of energy efficiency class F	LED-verlichting onder kast, 5,8 watt, 6000 Kelvin, 320 lumen, 230 volt, 1 mtr. levering inclusief schakelaar  Dit product bevat een lichtbron van energie- efficiëntieklasse F	éclairage à LED sous l'armoire, 5,8 watts, 6000 Kelvin, 320 lumens, 230 volts, 1 mtr. alimentation avec interrupteur Ce produit contient une source lumineuse de la classe d'efficacité énergétique F	57,0	NBP60	



## Zubehör / accessories / accessories / accessories

	Maße dimension afmetingen dimensions	B = Breite / width / breedte / largeur cm H = Höhe / height / hoogte / hauteur cm T = Tiefe / depth / diepte / profondeur cm				B = Breite	Artikel-Nr. article-no. artikel nr. article n°.	Identnr./ID no./ID-nr./no.-ID
		DE	EN	NL	FR			Y10
	T = 43,5 cm	Einbauspüle mit Stopfventil, Edelstahl inkl. Ab- und Überlaufgarnitur AG-EB	built-in sink with plug valve, stainless steel incl. drain and overflow set AG-EB	ingebouwde spoelbak met stopkraan, roestvrij staal incl. uit- en overloopset AG-EB	évier intégré avec robinet à boisseau, en acier inoxydable avec ensemble de drainage et de débordement AG-EB	86,0	EB1	
	T = 41,5 cm	Eckiges Becken mit Stopfventil, Edelstahl 18/10, inkl. Ab- und Überlaufgarnitur AG-EBE	angular basin with plug valve, 18/10 stainless steel, incl. drain and overflow fitting AG-EBE	vierkante bak met stopkraan, 18/10 roestvrij staal, incl. uit- en overloopgarnituur AG-EBE	cuve carrée avec robinet à boisseau, acier inoxydable 18/10, avec ensemble de drainage et de débordement AG-EBE	51,8	EBE42	
	T = 45,0 cm	Rundes Becken mit Stopfventil, Edelstahl	round basin with plug valve, stainless steel	ronde wasbak met stopkraan, roestvrij staal	bassin rond avec robinet à boisseau, acier inoxydable	45,0	EBR45	
	T = 43,5 cm	Einbauspüle mit Stopfventil, Edelstahl	built-in sink with plug valve, stainless steel	ingebouwde spoelbak met stopkraan, roestvrij staal	évier intégré avec robinet à boisseau, en acier inoxydable	78,0	EBS78	
	T = 50,0 cm	Einbauspüle mit Siebkorb als Excenterventil 3 1/2", Edelstahl seidenmatt, 2 Lochbohrungen	built-in sink with strainer basket as eccentric valve 3 1/2", satin stainless steel, 2 drilled holes	ingebouwde spoelbak met zeefkorf als excentrisch ventiel 3 1/2", roestvrijstalen satijnen afwerking, 2 boorgaten	évier encastré avec panier-filtre comme soupape excentrique 3 1/2", acier inoxydable satiné, 2 trous percés	86,0	EBS86	
	T = 50,0 cm	Einbauspüle mit Siebkorb als Excenterventil 3 1/2", Edelstahl seidenmatt, mit Resteschale Edelstahl, 2 Lochbohrungen	built-in sink with strainer basket as eccentric valve 3 1/2", stainless steel satin finish, with stainless steel waste bowl, 2 drilled holes	ingebouwde spoelbak met zeefkorf als excentrisch ventiel 3 1/2", roestvrijstalen satijnen afwerking, met roestvrijstalen afvalbak, 2 boorgaten	évier encastré avec panier-filtre comme soupape excentrique 3 1/2", acier inoxydable satiné, avec cuvette à déchets en acier inoxydable, 2 trous percés	96,5	EBS96	
	T = 43,5 cm	Einbauspüle Mineralmarmor Fb. granit Ablauf mit Siebkorbventil, Beckentiefe 180 mm, Überlauf Edelstahl	Built-in sink mineral marble col. granite Drain with strainer basket valve, basin depth 180 mm, stainless steel overflow	Ingebouwde spoelbak mineraal marmer kleur graniet. Afvoer met zeefkorfventiel, bassindiepte 180 mm, RVS overloop	Évier encastrable marbre minéral couleur granit. Bonde avec vanne à panier-filtre, profondeur cuve 180 mm, trop-plein inox	86,5	EBG	

## Zubehör Wandabschlussprofil

accessories wall end profile / accessoires wand-eindprofiel / accessoires profilé de finition murale

	Maße dimension afmetingen dimensions	B = Breite / width / breedte / largeur cm L = Länge / length / lengte / longueur cm				L = Länge	Artikel-Nr. article-no. artikel nr. article n°.	Identnr./ID no./ID-nr./no.-ID
		DE	EN	NL	FR			Y10
	H = 1,5 cm T = 1,5 cm	Wandabschlussprofil inkl. 2 Endkappen Kunststoff Edelstahl-Optik	wall end profile incl. 2 end caps Plastic stainless steel look	wandafsluitprofiel incl. 2 eindkappen Kunststof RVS look	profilé d'extrémité de mur avec 2 embouts Plastique aspect inox	211,5 281,5	WAP21-205 WAP28-205	

## Arbeitsplatten 28 mm

worktop / werkbladen / plans de travail

Maße dimension afmetingen dimensions	B = Breite / width / breedte / largeur cm H = Höhe / height / hoogte / hauteur cm T = Tiefe / depth / diepte / profondeur cm				B = Breite	Artikel-Nr. article-no. artikel nr. article n°.	Identnr./ID no./ID-nr./ID
	DE	EN	NL	FR			
H = 2,8 cm T = 60,0 cm	Arbeitsplatte mit Dickkantenprofil	worktop with thick edge profile	werkblad met dik randprofiel	plan de travail avec profil de bord épais	30,0	A30-037 A30-055 A30-164 A30-190 A30-257 A30-656	
H = 2,8 cm T = 60,0 cm	Arbeitsplatte mit Dickkantenprofil	worktop with thick edge profile	werkblad met dik randprofiel	plan de travail avec profil de bord épais	40,0	A40-037 A40-055 A40-164 A40-190 A40-257 A40-656	
H = 2,8 cm T = 60,0 cm	Arbeitsplatte mit Dickkantenprofil	worktop with thick edge profile	werkblad met dik randprofiel	plan de travail avec profil de bord épais	50,0	A50-037 A50-055 A50-164 A50-190 A50-257 A50-656	
H = 2,8 cm T = 60,0 cm	Arbeitsplatte mit Dickkantenprofil	worktop with thick edge profile	werkblad met dik randprofiel	plan de travail avec profil de bord épais	60,0	A60-037 A60-055 A60-164 A60-190 A60-257 A60-656	
H = 2,8 cm T = 60,0 cm	Arbeitsplatte mit Dickkantenprofil	worktop with thick edge profile	werkblad met dik randprofiel	plan de travail avec profil de bord épais	80,0	A80-037 A80-055 A80-164 A80-190 A80-257 A80-656	
H = 2,8 cm T = 60,0 cm	Arbeitsplatte mit Dickkantenprofil	worktop with thick edge profile	werkblad met dik randprofiel	plan de travail avec profil de bord épais	90,0	A90-037 A90-055 A90-164 A90-190 A90-257 A90-656	
H = 2,8 cm T = 60,0 cm	Arbeitsplatte mit Dickkantenprofil	worktop with thick edge profile	werkblad met dik randprofiel	plan de travail avec profil de bord épais	100,0	A100-037 A100-055 A100-164 A100-190 A100-257 A100-656	
H = 2,8 cm T = 60,0 cm	Arbeitsplatte mit Dickkantenprofil	worktop with thick edge profile	werkblad met dik randprofiel	plan de travail avec profil de bord épais	110,0	A110-037 A110-055 A110-164 A110-190 A110-257 A110-656	
H = 2,8 cm T = 60,0 cm	Arbeitsplatte mit Dickkantenprofil	worktop with thick edge profile	werkblad met dik randprofiel	plan de travail avec profil de bord épais	120,0	A123-037 A123-055 A123-164 A123-190 A123-257 A123-656	
H = 2,8 cm T = 60,0 cm	Arbeitsplatte mit Dickkantenprofil	worktop with thick edge profile	werkblad met dik randprofiel	plan de travail avec profil de bord épais	150,0	A153-037 A153-055 A153-164 A153-190 A153-257 A153-656	
H = 2,8 cm T = 60,0 cm	Arbeitsplatte mit Dickkantenprofil	worktop with thick edge profile	werkblad met dik randprofiel	plan de travail avec profil de bord épais	170,0	A173-037 A173-055 A173-164 A173-190 A173-257 A173-656	
H = 2,8 cm T = 60,0 cm	Arbeitsplatte mit Dickkantenprofil	worktop with thick edge profile	werkblad met dik randprofiel	plan de travail avec profil de bord épais	210,0	A213-037 A213-055 A213-164 A213-190 A213-257 A213-656	



-037  
Akazie Nachbildung  
acacia decor  
akazia decor  
décor acacia clair



-055  
Pinie Champagner Nachbildung  
pine champagne  
pinjboom champagne  
pin prasol champagne



-164  
Eiche Trüffel Nachbildung  
truffled oak decor  
truffel eiken decor  
décor chêne trufflé



-190  
Wildeiche Nachbildung  
wild oak finish  
afwerking in wilde eik  
finition en chêne sauvage



-257  
Eiche-hell sägerau Nachbildung  
light oak decor  
licht eiken decor  
décor chêne clair

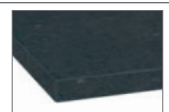







-656  
Anthrazit  
antraciet  
anthraciet  
anthracite

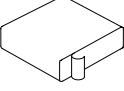

## Arbeitsplatten Kantenumleimer

working top edge banding / werkbladen randlijm / plan de travail bande de chant

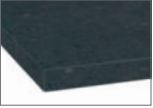
	Maße dimension afmetingen dimensions	B = Breite / width / breedte / largeur cm H = Höhe / height / hoogte / hauteur cm T = Tiefe / depth / diepte / profondeur cm				B = Breite	Artikel-Nr. article-no. artikel nr. article n°.	Identnr./ID no./ID-nr./no.-ID			
		DE	EN	NL	FR						
	T = 60,0 cm	Kantenumleimer 28 mm mit Schmelzkleber	edge banding 28 mm with hot melt adhesive	randlijm 28 mm met smeltlijm	bande de chant 28 mm avec adhésif thermofusible	65,0	AUML-037 AUML-055 AUML-164 AUML-190 AUML-257 AUML-656	Y10			
	-037 Akazie Nachbildung acacia decor akazia decor décor acacia clair		-055 Pinie Champagner Nachbildung pine champagne pijnboom champagne pin prasol champagne		-164 Eiche Trüffel Nachbildung truffled oak decor truffel eiken decor décor chêne trufflé		-190 Wildeiche Nachbildung wild oak finish afwerking in wilde eik finition en chêne sauvage		-257 Eiche-hell sägerau Nachbildung light oak decor licht eiken decor décor chêne clair		-656 Anthrazit anthracite antraciet anthracite

# Zubehör / accessories / accessories / accessories

## Arbeitsplatten 38 mm

worktop / werkbladen / plans de travail

Maße dimension afmetingen dimensions	B = Breite / width / breedte / largeur cm H = Höhe / height / hoogte / hauteur cm T = Tiefe / depth / diepte / profondeur cm L = Länge / length / lengte / longueur cm				B = H = T = B	Artikel-Nr. article-no. artikel nr. article n°.	Identnr./ID no./ID-nr./no.-ID  Y10
	DE	EN	NL	FR			
H = 3,8 cm T = 60,0 cm	Arbeitsplatte mit Doppelrundprofil	worktop with double rounded edge	werkblad met dubbel rond profiel	plan de travail avec profilé rond double	60,0	A64-205 A64-190	
H = 3,8 cm T = 60,0 cm	Arbeitsplatte mit Doppelrundprofil	worktop with double rounded edge	werkblad met dubbel rond profiel	plan de travail avec profilé rond double	100,0	A104-205 A104-190	
H = 3,8 cm T = 60,0 cm	Arbeitsplatte mit Doppelrundprofil	worktop with double rounded edge	werkblad met dubbel rond profiel	plan de travail avec profilé rond double	120,0	A124-205 A124-190	
H = 3,8 cm T = 60,0 cm	Arbeitsplatte mit Doppelrundprofil	worktop with double rounded edge	werkblad met dubbel rond profiel	plan de travail avec profilé rond double	150,0	A154-205 A154-190	
H = 3,8 cm T = 60,0 cm	Arbeitsplatte mit Doppelrundprofil	worktop with double rounded edge	werkblad met dubbel rond profiel	plan de travail avec profilé rond double	160,0	A164-205 A164-190	
H = 3,8 cm T = 60,0 cm	Arbeitsplatte mit Doppelrundprofil	worktop with double rounded edge	werkblad met dubbel rond profiel	plan de travail avec profilé rond double	210,0	A214-205 A214-190	
H = 3,8 cm T = 60,0 cm	Arbeitsplatte mit Doppelrundprofil Winkel rechts inkl. Ausfräsung	worktop with double rounded edge angle right incl. milling	werkblad met dubbel rond profiel hoek rechts incl. frezen	plan de travail avec profilé rond double angle droit y compris fraisage	200,0	A204VR-205 A204VR-190	
					150,0		
H = 3,8 cm T = 60,0 cm	Arbeitsplatte mit Doppelrundprofil Winkel links inkl. Ausfräsung	worktop with double rounded edge angle left incl. milling	werkblad met dubbel rond profiel linker hoek incl. frezen	plan de travail avec profilé rond double angle gauche y compris fraisage	200,0	A204VL-205 A204VL-190	
					150,0		

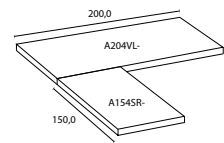
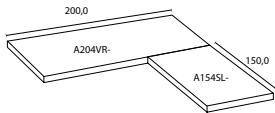

Black Stone -205  
black stone  
zwarte steen  
pierre noire



Wildeiche Nachbg. -190  
wild oak finish  
afwerking in wilde eik  
finition en chêne sauvage

## Arbeitsplatten Kantenumleimer

working top edge banding / werkbladen randlijm / plan de travail bande de chant

Maße dimension afmetingen dimensions	B = Breite / width / breedte / largeur cm H = Höhe / height / hoogte / hauteur cm T = Tiefe / depth / diepte / profondeur cm				B = B =	Artikel-Nr. article-no. artikel nr. article n°.	Identnr./ID no./ID-nr./no.-ID  Y10
	DE	EN	NL	FR			
T = 60,0 cm	Kantenumleimer 38 mm mit Schmelzkleber	edge banding 38 mm with hot melt adhesive	randlijm 38 mm met smeltlijm	bande de chant 38 mm avec adhésif thermofusible	65,0	AU38-205 AU38-190	

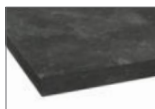
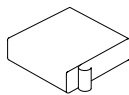

Black Stone -205  
black stone  
zwarte steen  
pierre noire



Wildeiche Nachbg. -190  
wild oak finish  
afwerking in wilde eik  
finition en chêne sauvage