

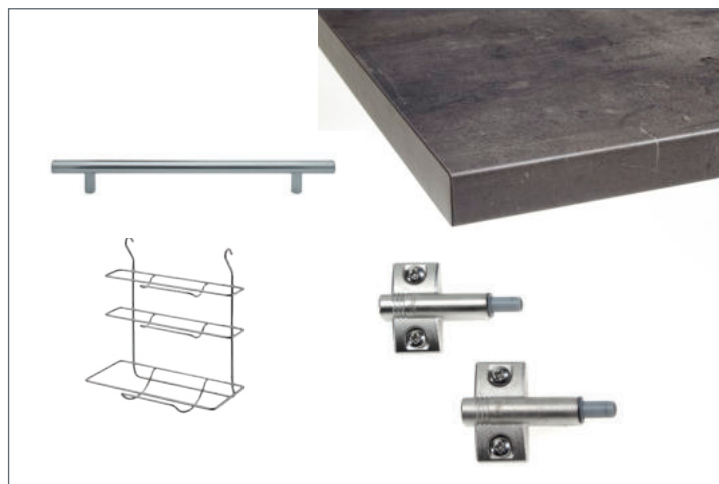







Zubehör / accessories / accessories / accessories

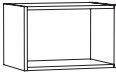

Farbige Regale

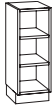
coloured shelves / gekleurde schappen / étagères colorées

	Maße dimension afmetingen dimensions	B = Breite / width / breedte / largeur cm H = Höhe / height / hoogte / hauteur cm T = Tiefe / depth / diepte / profondeur cm				B = Breite	Artikel-Nr. article-no. artikel nr. article n°.	Identnr./ID no./ID-nr./no.-ID Y10
	H = 19,2 cm T = 34,6 cm	Oberschrankregal	wall unit storage shelf	hangkasten rek	étagère murale	40,0	OR419+	
						50,0	OR519+	
						60,0	OR619+	nicht in Anthrazit erhältlich not available in anthracite niet leverbaar in antraciet non disponible en anthracite
	H = 32,0 cm T = 34,6 cm	Oberschrankregal	wall unit storage shelf	hangkasten rek	étagère murale	40,0	OR432+	
						50,0	OR532+	
	H = 35,2 cm T = 34,6 cm	Oberschrankregal	wall unit storage shelf	hangkasten rek	étagère murale	30,0	OR335+	nicht in Anthrazit erhältlich not available in anthracite niet leverbaar in antraciet non disponible en anthracite
	H = 35,2 cm T = 34,6 cm	Oberschrankregal	wall unit storage shelf	hangkasten rek	étagère murale	30,0	OR357+	
		1 Glaseinlegeboden	1 glass shelf	1 glazen plank	1 étagère en verre	40,0	OR457+	
						50,0	OR557+	
	H = 44,4 cm T = 34,6 cm	Oberschrankregal	wall unit storage shelf	hangkasten rek	étagère murale	150,0	SR1550+	nicht in Anthrazit erhältlich not available in anthracite niet leverbaar in antraciet non disponible en anthracite
		1 Schiebeelem. 50 cm 1 Glaseinlegeboden 2 Designstangen in Edelstahl-Optik	1 sliding door 50 cm 1 glass shelf 2 designposts in stainless-steel optic	1 schuifdeur 50 cm 1 glazen plank 2 designposten in roestvrijstalen optiek	1 porte coulissante 50 cm 1 étagère en verre 2 tiges de design en optique en acier inoxydable.			
	H = 44,4 cm T = 34,6 cm	Oberschrankregal	wall unit storage shelf	hangkasten rek	étagère murale	150,0	SR1575+	
		1 Schiebeelement 75 cm	1 sliding door panel 75 cm	1 schuifdeur 75 cm	1 porte coulissante 75 cm			
	H = 82,0 cm T = 34,6 cm	Unterschrank-/ Oberschrankregal	base unit / wall unit storage	hangkasten / onderkasten rek	étagère murale / bas	30,0	UR382+	nicht in Anthrazit erhältlich not available in anthracite niet leverbaar in antraciet non disponible en anthracite
		2 Z-Böden ohne Arbeitsplatte	2 mounted shelves without worktop	2 legplanken zonder werkblad	2 étagères montées sans plan de travail			
	H = 86,8 cm T = 13,6 cm	Rückwandpaneel	wall panel with storage shelves	wandpaneel met rek	panneau mural	50,0	RP587+	nicht in Anthrazit erhältlich not available in anthracite niet leverbaar in antraciet non disponible en anthracite
		2 Ablageböden	2 shelves	2 planken	2 étagères			

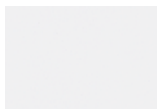

RWE
Weiß
white
wit
blanc



RAN*
Anthrazit
anthracite
antraciet
anthracite



REI
Eiche hell Nachbildg.
light oak decor
licht eiken decor
décor chêne clair



ROP
Opal
opal green
opaalgroen
opale verte





RRO
Rot
red
rood
rouge



RAK
Akazie Nachbildung
acacia decor
akazia decor
décor acacia clair

Oberschränke mit Glasrahmentür in Alu-Optik

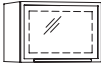
wall units with framed glass doors in aluminium-optics/ hangkasten met ingelijste glazen deuren in aluminium kleur/ éléments murale avec portes en verre encadrées en aspect aluminium

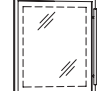
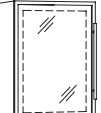

	Maße dimension afmetingen dimensions	B = Breite / width / breedte / largeur cm H = Höhe / height / hoogte / hauteur cm T = Tiefe / depth / diepte / profondeur cm				B = Breite	Artikel-Nr. article-no. artikel nr. article n°.	Identnr./ID no./ID-nr./no.-ID	
								Y10	
	H = 35,2 cm T = 35,2 cm	Oberschrank mit Glasrahmenklappe in Alu-Optik	wall unit with aluminium-colour framed glass flap	hangkast met aluminiumkleurige ingelijste glasklep	élément murale avec volet en verre encadré de couleur aluminium	50,0	OKA535		
			1x Stangengriff in Edelstahl-Optik	1x handle bar in stainless steel optics	1x duwstang in roestvrijstalen optiek	1x poignée en optique inox	60,0		OKA635
	H = 35,2 cm T = 35,2 cm	Oberschrank mit Glasrahmenklappe in Alu-Optik	wall unit with aluminium-colour framed glass flap	hangkast met aluminiumkleurige ingelijste glasklep	élément murale avec volet en verre encadré de couleur aluminium	80,0	OKA835		
			1x Stangengriff in Edelstahl-Optik	1x handle bar in stainless steel optics	1x duwstang in roestvrijstalen optiek	1x poignée en optique inox	90,0		OKA935
							100,0		OKA135
	H = 57,6 cm T = 35,2 cm	Oberschrank mit Glasrahmentür in Alu-Optik	wall unit with aluminium-colour framed glass door	hangkast met aluminiumkleurige ingelijste glasklep	élément murale avec volet en verre encadré de couleur aluminium	50,0	OA506		
			1x Stangengriff in Edelstahl-Optik 1x Einlegeboden	1x handle bar in stainless steel optics 1x shelf	1x duwstang in roestvrijstalen optiek 1x plank	1x poignée en optique inox 1x étagère	60,0		OA606
	H = 70,4 cm T = 35,2 cm	Oberschrank mit Glasrahmentür in Alu-Optik	wall unit with aluminium-colour framed glass door	hangkast met aluminiumkleurige ingelijste glasklep	élément murale avec volet en verre encadré de couleur aluminium	50,0	OMA506		
			1x Stangengriff in Edelstahl-Optik 2x Einlegeboden	1x handle bar in stainless steel optics 2x shelves	1x duwstang in roestvrijstalen optiek 2x planken	1x poignée en optique inox 2x étagères	60,0		OMA606



Satiniertes Glas
Korpusfarbe weiß
satinéd glass
carcase colour white
gesatineerd glas
corpus kleur wit
verre satiné
couleur du caisson
blanc



















Griffe

handles / grepen / poignées

	Bohrabstand drilling distance boorafstand distance de forage	B = Breite / width / breedte / largeur cm H = Höhe / height / hoogte / hauteur cm T = Tiefe / depth / diepte / profondeur cm				B = Breite	Artikel-Nr. article-no. artikel nr. article n°.	Identnr./ID no./ID-nr./no.-ID	
								Y10	
			Zamak in Nickel-Optik gebürstet 2 Stück / Pack	zamac nickel optics, brushed 2 pieces / pack	geborsteld nikkel-look zamac 2 stuks / verpakking	zamac brossé aspect nickel 2 pièces / paquet	2,67	G639	
			Zamak in Nickel-Optik gebürstet 2 Stück / Pack	zamac nickel optics, brushed 2 pieces / pack	geborsteld nikkel-look zamac 2 stuks / verpakking	zamac brossé aspect nickel 2 pièces / paquet	3,51	G640	



Griffe Metall







handles metal / grepen metalen / poignées métalliques

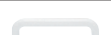

	Bohrabstand drilling distance boorafstand distance de forage	B = Breite / width / breedte / largeur cm H = Höhe / height / hoogte / hauteur cm T = Tiefe / depth / diepte / profondeur cm				Artikel-Nr. article-no. artikel nr. article n°.	Identnr./ID no./ID-nr./no.-ID
							Y10
	128 mm	Metall Edelstahl-Optik, gebürstet 2 Stück / Pack	metal stainless steel optic, brushed 2 pieces / pack	metaal in roestvrij staal look 2 stuks / verpakking	métal en aspect acier inoxydable 2 pièces / paquet	19,2	G021
	128 mm	Aluminium schwarz matt 2 Stück / Pack	aluminium mat black 2 pieces / pack	aluminium zwart mat 2 stuks / verpakking	aluminium noir mat 2 pièces / paquet	16,3	G463
	128 mm	Zamak in Nickel-Optik gebürstet 2 Stück / Pack	zamak nickel optics, brushed 2 pieces / pack	geborsteld nikkel-look zamac 2 stuks / verpakking	zamac brossé aspect nickel 2 pièces / paquet	13,7	G495
	128 mm	Aluminium Edelstahl-Optik, gebürstet 2 Stück / Pack	aluminium stainless steel optic, brushed 2 pieces / pack	aluminium roestvrij staal look, geborsteld 2 stuks / verpakking	aluminium Aspect acier inoxydable, brossé 2 pièces / paquet	13,7	G500
	192 mm	Zamak in Nickel-Optik gebürstet 2 Stück / Pack	zamak nickel optics, brushed 2 pieces / pack	geborsteld nikkel-look zamac 2 stuks / verpakking	zamac brossé aspect nickel 2 pièces / paquet	20,5	G603
	128 mm	Zamak in Nickel-Optik gebürstet 2 Stück / Pack	zamak nickel optics, brushed 2 pieces / pack	geborsteld nikkel-look zamac 2 stuks / verpakking	zamac brossé aspect nickel 2 pièces / paquet	14,2	G615
	128 mm	Aluminium Edelstahl-Optik, gebürstet 2 Stück / Pack	aluminium stainless steel optic, brushed 2 pieces / pack	aluminium roestvrij staal look, geborsteld 2 stuks / verpakking	aluminium Aspect acier inoxydable, brossé 2 pièces / paquet	16,0	G620
	128 mm	Aluminium Edelstahl-Optik, gebürstet 2 Stück / Pack	aluminium stainless steel optic, brushed 2 pieces / pack	aluminium roestvrij staal look, geborsteld 2 stuks / verpakking	aluminium Aspect acier inoxydable, brossé 2 pièces / paquet	25,7	G621
	2x 128 mm	Aluminium Edelstahl-Optik, gebürstet 2 Stück / Pack	aluminium stainless steel optic, brushed 2 pieces / pack	aluminium roestvrij staal look, geborsteld 2 stuks / verpakking	aluminium Aspect acier inoxydable, brossé 2 pièces / paquet	44,8	G622
	192 mm	Griffeiste Aluminium eloxiert 2 Stück / Pack	handle bar aluminium anodised 2 pieces / pack	geanodiseerde aluminium greeplijst 2 stuks / verpakking	bande de poignée en aluminium anodisé 2 pièces / paquet	23,0	G623
	128 mm	Zamak schwarz matt 2 Stück / Pack	zamak mat black 2 pieces / pack	zamak zwart mat 2 stuks / verpakking	zamac noir mat 2 pièces / paquet	14,2	G625
	192 mm	Metall Edelstahl-Optik, gebürstet 2 Stück / Pack	metal stainless steel optic, brushed 2 pieces / pack	metaal in roestvrij staal look 2 stuks / verpakking	métal en aspect acier inoxydable 2 pièces / paquet	25,6	G700
	256 mm	Metall Edelstahl-Optik, gebürstet 2 Stück / Pack	metal stainless steel optic, brushed 2 pieces / pack	metaal in roestvrij staal look 2 stuks / verpakking	métal en aspect acier inoxydable 2 pièces / paquet	32,0	G701
	352 mm	Metall Edelstahl-Optik, gebürstet 2 Stück / Pack	metal stainless steel optic, brushed 2 pieces / pack	metaal in roestvrij staal look 2 stuks / verpakking	métal en aspect acier inoxydable 2 pièces / paquet	41,6	G702
	448 mm	Metall Edelstahl-Optik, gebürstet 2 Stück / Pack	metal stainless steel optic, brushed 2 pieces / pack	metaal in roestvrij staal look 2 stuks / verpakking	métal en aspect acier inoxydable 2 pièces / paquet	51,2	G703
	544 mm	Metall Edelstahl-Optik, gebürstet 2 Stück / Pack	metal stainless steel optic, brushed 2 pieces / pack	metaal in roestvrij staal look 2 stuks / verpakking	métal en aspect acier inoxydable 2 pièces / paquet	60,8	G704
	704 mm	Metall Edelstahl-Optik, gebürstet 2 Stück / Pack	metal stainless steel optic, brushed 2 pieces / pack	metaal in roestvrij staal look 2 stuks / verpakking	métal en aspect acier inoxydable 2 pièces / paquet	76,8	G705
	160 mm	Metall Edelstahl-Optik, gebürstet 2 Stück / Pack	metal stainless steel optic, brushed 2 pieces / pack	metaal in roestvrij staal look 2 stuks / verpakking	métal en aspect acier inoxydable 2 pièces / paquet	17,9	G733

Griffe Kunststoff











handles plastic / grepen kunststof / poignées en plastique

	Bohrabstand drilling distance boorafstand distance de forage	B = Breite / width / breedte / largeur cm H = Höhe / height / hoogte / hauteur cm T = Tiefe / depth / diepte / profondeur cm				B = Breite	Artikel-Nr. article-no. artikel nr. article n°.	Identnr./ID no./ID-nr./no.-ID Y10
	128 mm	Kunststoff in Alu-Optik plastic, aluminium optics	plastic, aluminium optics	kunststof in aluminium-look	le plastique à l'aspect aluminium	16,36	G418	
	128 mm	Kunststoff, Bronze-grau 2 Stück / Pack	plastic bronze grey 2 pieces / pack	kunststof bronzen grijs 2 stuks / verpakking	matière plastique, gris bronze 2 pièces / paquet	14,34	G472	
	96 mm	Kunststoff, Silber-grau 2 Stück / Pack	plastic silvergrey 2 pieces / pack	kunststof zilver grijs 2 stuks / verpakking	matière plastique, gris argent 2 pièces / paquet	10,69	G530	
	96 mm	Kunststoff, Weiß 2 Stück / Pack	plastic white 2 pieces / pack	kunststof wit 2 stuks / verpakking	matière plastique blanc 2 pièces / paquet	10,59	G851	

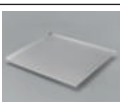

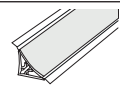



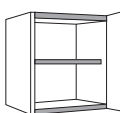

	Maße dimension afmetingen dimensions	B = Breite / width / breedte / largeur cm H = Höhe / height / hoogte / hauteur cm T = Tiefe / depth / diepte / profondeur cm				B = Breite	Artikel-Nr. article-no. artikel nr. article n°.	Identnr./ID no./ID-nr./no.-ID Y10
	T = 43,5 cm	Einbauspüle mit Stopfventil, Edelstahl inkl. Ab- und Überlaufgarnitur AG-EB	built-in sink with plug valve, stainless steel incl. drain and overflow set AG-EB	ingebouwde spoelbak met stopkraan, roestvrij staal incl. uit- en overloopset AG-EB	évier intégré avec robinet à boisseau, en acier inoxydable avec ensemble de drainage et de débordement AG-EB	86,0	EB1	
	T = 41,5 cm	Eckiges Becken mit Stopfventil, Edelstahl 18/10, inkl. Ab- und Überlaufgarnitur AG-EBE	angular basin with plug valve, 18/10 stainless steel, incl. drain and overflow fitting AG-EBE	vierkante bak met stopkraan, 18/10 roestvrij staal, incl. uit- en overloopgarnituur AG-EBE	cuve carrée avec robinet à boisseau, acier inoxydable 18/10, avec ensemble de drainage et de débordement AG-EBE	51,8	EBE42	
	T = 45,0 cm	Rundes Becken mit Stopfventil, Edelstahl	round basin with plug valve, stainless steel	ronde wasbak met stopkraan, roestvrij staal	bassin rond avec robinet à boisseau, acier inoxydable	45,0	EBR45	
	T = 43,5 cm	Einbauspüle mit Stopfventil, Edelstahl	built-in sink with plug valve, stainless steel	ingebouwde spoelbak met stopkraan, roestvrij staal	évier intégré avec robinet à boisseau, en acier inoxydable	78,0	EBS78	
	T = 50,0 cm	Einbauspüle mit Siebkorb als Excenterventil 3 1/2", Edelstahl seidenmatt, 2 Lochbohrungen	built-in sink with strainer basket as eccentric valve 3 1/2", satin stainless steel, 2 drilled holes	ingebouwde spoelbak met zeefkorf als excentrisch ventiel 3 1/2", roestvrijstalen satijnen afwerking, 2 boorgaten	évier encastré avec panier-filtre comme soupape excentrique 3 1/2", acier inoxydable satiné, 2 trous percés	86,0	EBS86	
	T = 50,0 cm	Einbauspüle mit Siebkorb als Excenterventil 3 1/2", Edelstahl seidenmatt, mit Resteschale Edelstahl, 2 Lochbohrungen	built-in sink with strainer basket as eccentric valve 3 1/2", stainless steel satin finish, with stainless steel waste bowl, 2 drilled holes	ingebouwde spoelbak met zeefkorf als excentrisch ventiel 3 1/2", roestvrijstalen satijnen afwerking, met roestvrijstalen afvalbak, 2 boorgaten	évier encastré avec panier-filtre comme soupape excentrique 3 1/2", acier inoxydable satiné, avec cuvette à déchets en acier inoxydable, 2 trous percés	96,5	EBS96	

	H = 10,0 cm T = 0,4 cm	LED-Unterbauleuchte EEK A, 5,8 Watt, 6000 Kelvin, 320 Lumen, 230 Volt, 1 mtr. Zuleitung inkl. Schalter	LED under-cabinet light EEK A, 5,8 watts, 6000 Kelvin, 320 lumens, 230 volts, 1 mtr. supply including switch	LED-verlichting onder kast EEK A, 5,8 watt, 6000 Kelvin, 320 lumen, 230 volt, 1 mtr. levering inclusief schakelaar	éclairage à LED sous l'armoire EEK A, 5,8 watts, 6000 Kelvin, 320 lumens, 230 volts, 1 mtr. alimentation avec interrupteur	57,0	NBP60	
	H = 10,0 cm T = 0,4 cm	LED-Unterbauleuchte 2-er Set, EEK A, 6 Watt, 4000 Kelvin, 2x 150 Lumen, 230 Volt, 1 mtr. + 0,5 mtr. Zuleitung inkl. Schalter	LED under-cabinet light set of 2, EEK A, 6 watts, 4000 Kelvin, 2x 150 lumens, 230 volts, 1 mtr. + 0,5 mtr. supply including switch	LED onderbouwverlichting, set van 2, EEK A, 6 watt, 4000 Kelvin, 2x 150 lumen, 230 volt, 1 mtr. + 0,5 mtr. levering inclusief schakelaar	éclairage à LED sous l'armoire, jeu de 2, EEK A, 6 watts, 4000 Kelvin, 2x 150 lumens, 230 volts, 1 mtr. + 0,5 mtr. alimentation avec interrupteur	10,0	NBF210	

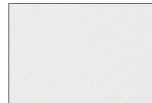
Zubehör / accessories / accessories / accessories

Maße dimension afmetingen dimensions	B = Breite / width / breedte / largeur cm H = Höhe / height / hoogte / hauteur cm T = Tiefe / depth / diepte / profondeur cm				B = Breite	Artikel-Nr. article-no. artikel nr. article n°.	Identnr./ID no./ID-nr./no.-ID
	Y10						
		Relingsystem <i>railing system</i>	<i>railing system</i>	<i>railing systeem</i>	<i>système de garde-corps</i>	120,0	RS
		Papierrollenhalter verchromt	<i>paper roll holder chrome</i>	<i>verchromde toile- trouhouder</i>	<i>porte-papier toilette chromé</i>		ZT891
		Dämpfungssystem für Türen für Clipscharnier je 2 Stück / Pack Bestelleinheit 10 Stück	<i>damping-system for doors for clip hinge 2 pcs / unit order unit 10 pieces</i>	<i>dempingssysteem voor deuren voor clipscharnier 2 stuks / eenheid besteleenheid 10 stuks</i>	<i>système de l'atténuation pour portes pour charnière à clip 2 pcs / unité commande unité 10 pièces</i>		BLU-MT2
		Dämpfungssystem für Türen je 2x Stück / Pack für 1x Tür = 1x Stück Bestelleinheit 10 Stück	<i>damping-system for doors 2x pcs / unit for 1x door = 1x piece order unit 10 pieces</i>	<i>dempingssysteem voor deuren elk 2x per stuk / verpakking voor 1x deur = 1x stuk besteleenheid 10 stuks</i>	<i>système d'amortissement pour les portes chaque 2x pièce / paquet pour 1x porte = 1x pièce unité de commande 10 pièces</i>		BLU232
	H = 7,4 cm	Sockel-Lüftungsgitter Kunststoff Aluminium Optik, 50 cm breit	<i>base ventilation grille plastic aluminium optic, 50 cm wide</i>	<i>sokkel ventilatierooster kunststof, aluminium look, 50 cm breed</i>	<i>base grille de ventilation en plastique, aspect aluminium, largeur 50 cm</i>	46,9	LG
	T = 50,1 cm	Tropfschutzblech Einlegeblech Aluminium	<i>drip protection panel inner panel aluminium</i>	<i>lekbak insteekplaat aluminium</i>	<i>plateau d'égouttage plaque d'insertion aluminium</i>	46,6	SBB50-8
						56,6	SBB60-8
						86,6	SBB90-8
						96,6	SBB100-8
	H = 2,5 cm	Montageschiene zur Aufhängung von Oberschränken Bestelleinheit 10 Stück	<i>mounting rail for suspension of wall units order unit 10 piece</i>	<i>montagerail voor hangende boven- kasten besteleenheid 10 stuks</i>	<i>rail de montage pour suspendre des éléments hauts unité de commande 10 pièces</i>	210,0	MS210-8
	H = 1,5 cm T = 1,5 cm	Wandanschlussprofil in Edelstahl-Optik inkl. Endkappen	<i>splashback in stainless steel look incl. end caps</i>	<i>wandaansluitprofiel in roestvrijstalen look incl. eindkappen</i>	<i>profil de connexion au mur en acier inoxydable- le, avec embouts</i>	211,5	WAP-205
	H = 5,0 cm T = 2,5 cm	Wandanschlussprofil in Alu-Optik	<i>splashback in aluminium optics</i>	<i>wandaansluitprofiel in aluminium look</i>	<i>profil de connexion au mur aspect aluminium</i>	500,0	WAL-081
		Zubehöropaket Wandanschlussprofil in Alu-Optik 1 Innenecke 90° 2 Endkappe	<i>accessorie package splashback in aluminium optics 1 inner corner 90° 2 end caps</i>	<i>accessoirepakket wandaansluitprofiel in aluminium look 1 binnenhoek 90° 2 eindkap</i>	<i>pack d'accessoires profil de connexion au mur en acier aluminium 1 coin intérieur 90° 2 embouts</i>		WAZ-081
		Markierhilfe/Ankörnhilfe für Grifflochbohrungen	<i>marking aid template for handle drillings</i>	<i>markeringshulpsjabloon voor handgriepbo- ringen</i>	<i>gabarit d'aide au marquage pour les perçages de poignées</i>	34,5	BSCHABLONE
	T = 28,4 cm	Glaseinlegeboden 2 Stück, ESG	<i>glass shelf 2 pieces</i>	<i>glazen plank 2 stukken</i>	<i>étagère en verre 2 pièces</i>	46,2	GBESG50-8

Zubehör / accessories / accessories/ accessories

Maße dimension afmetingen dimensions	B = Breite / width / breedte / largeur cm H = Höhe / height / hoogte / hauteur cm T = Tiefe / depth / diepte / profondeur cm				Artikel-Nr. article-no. artikel nr. article n°.	Identnr./ID no./ID-nr./no.-ID	
	B = Breite					Y10	Y10 -990
 H = 1,6 cm Kantenumleimer 16 mm selbstklebend	edge banding 16 mm self adhesive	kantenband 16 mm zelfklevend	bande de chant 16 mm auto-adhésive	500,0	KANTE5-		
 -025 Basaltgrau basalt grey basaltgrijs gris basalte	 -037 Akazie Nachbildung acacia decor akazia decor décor acacia clair	 -110 Weiß white wit blanc	 -156 Pinie-nougat Nachb. pine nougat decor decor pijnboom nougat décor pin parasol nougat	 -157 Eiche hell Nachbg. light oak decor licht eiken decor décor chêne clair	 -175 Beton-Optik cement optics beton decor décor béton	 -190 Wildeiche Nachbg. wild oak finish afwerking in wilde eik finition en chêne sauvage	 -990 Weiß Hochglanz white high gloss witte hoogglans blanc haute brillance

