



OPTI**premio** vormontierte Möbel **light**



Qualität selbstverständlich

quality as a matter of course
kwaliteit als vanzelfsprekend
la qualité, une évidence

Vormontierte Möbel
rigid furniture
voorgemonteerd meubilair
meubles assemblés

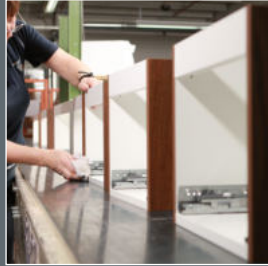

Vollauszüge mit Softclose bei Schubkästen und Auszügen inklusive
full pull-outs with softclose for drawers and extracts included
volledig uittrekbaar met softclose voor laden en uittreksels inbegrepen
coulissants complète avec softclose pour les tiroirs et extraits inclus

Türdämpfer, softclosing inklusive
door damping, soft close included
deurdemping, soft close inbegrepen
atténuation de porte, fermeture en douceur incluse

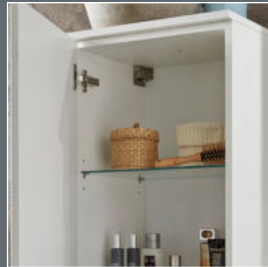

Einlegeböden aus Sicherheitsglas
safety glass shelves
planken van veiligheidsglas
étagères en verre de sécurité

Alle Schränke wandhängend
all cabinets wall mounted
alle kasten wandhangend
toutes les armoires sont fixées au mur

Waschtische aus Keramik
ceramic washbasins
keramische wastafels
lavabos en céramique



Folienbeschichtung
• Möbelkanten abgerundet und 100 % wie Frontfarbe
• 100 % Oberflächenversiegelung

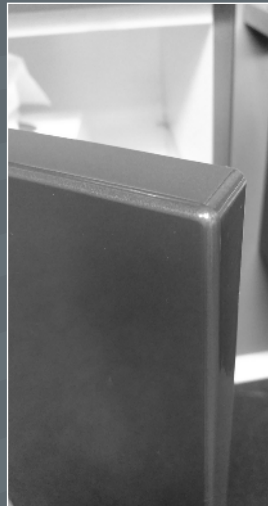

Foil coating
• furniture edges rounded and 100% like front colour
• 100% surface sealing

Folie coating
• meubelranden afgerond en 100% zoals frontkleur
• 100% oppervlakteafdichting

Revêtement en feuille
• bords des meubles arrondis et 100% comme la couleur de façade
• 100% étanchéité de surface

Melamin-Beschichtung
• Möbelkanten farblich angepasst und leicht gerundet, Dickkante



Melamine coating
• furniture edges colour-matched and slightly rounded, thick edge

Melamine coating
• meubelranden op elkaar afgestemd in kleur en licht afgeronde, dikke rand

Revêtement mélaminé
• bords de meubles de couleur assortie et bord épais légèrement arrondi



Made in Germany

JAKA-BKL GmbH | Jaka-Str. 3 | 32351 Stemwede | Tel. +49 (0) 5773 / 88-0 | www.optifit.de | info@jaka-bkl.de

OPTipremio light

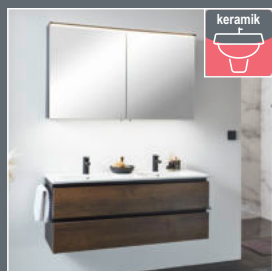

inkl. Beistellmöbel
incl. side cabinets
incl. zijkasten
incl. meubles latéraux

2510clarus 04 - 09

Breiten / width / breedten / largeurs

80 cm | 100 cm | 120 cm

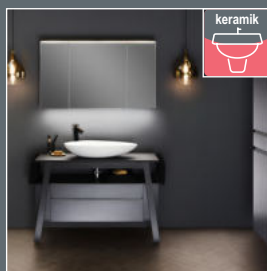

inkl. Beistellmöbel
incl. side cabinets
incl. zijkasten
incl. meubles latéraux

2500maxus 10 - 19

Breiten / width / breedten / largeurs

100 cm | 120 cm

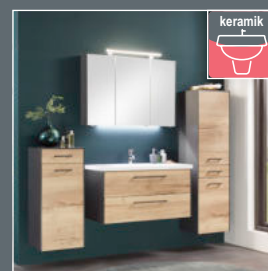

inkl. Beistellmöbel
incl. side cabinets
incl. zijkasten
incl. meubles latéraux

2400modern 20 - 25

Breiten / width / breedten / largeurs

80 cm | 100 cm



inkl. Beistellmöbel
incl. side cabinets
incl. zijkasten
incl. meubles latéraux

2060daily 26 - 32

Breiten / width / breedten / largeurs

65 cm | 85 cm | 95 cm

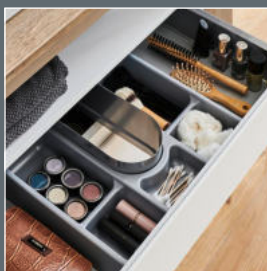

Zubehör 32 - 35



Keramik Waschtisch

ceramic washbasin
keramische wastafel
lavabo en céramique



LED mit Bewegungssensor

LED with motion sensor
LED met bewegingssensor
LED avec détecteur de mouvement



LED-Lichtfarbe kalt, 6000 Kelvin

LED colour temperature cold, 6000 K.
LED kleurtemperatuur koud, 6000 K.
Température de couleur de la LED froide, 6000 K.



LED-Lichtfarbe warm, 4000 Kelvin

LED colour temperature warm, 4000 K.
LED kleurtemperatuur warm, 4000 K.
Température de couleur de la LED chaude, 4000 K.



LED Lichtfarbe regelbar

LED colour temperature adjustable
LED lichtkleur instelbaar
Couleur de la lumière LED réglable



LED mit Sensorschalter, Helligkeit dimmbar

LED with sensor switch, temperature adjustable
LED met sensorschakelaar, helderheid dimbaar
LED avec interrupteur à sensor, luminosité variable

Farbkombinationen Front / Korpus

colour combinations front / carcass | kleurencombinaties front / corpus | combinaisons de couleurs façade / caisson



DE

Front/Korpus haben standardmäßig die gleiche Farbe.
Zusätzlich können andere Varianten gewählt werden.
Preisgrundlage ist die Preisgruppe der Korpusfarbe.
Beispiel Programm 2060

Front Eiche Struktur Natur Nachbildung **KDM_**
Korpus Weiß Seidenglanz **_E**
= Bestellnummer **KDME**
Eiche Struktur Natur Nachbildung / Weiß Seidenglanz

EN

Front/carcass have the same colour as standard.
Other variants can also be chosen.
The price basis is the price group of the carcass colour.
Example program 2060

Front Oak structure nature finish **KDM_**
Carcass Silk gloss white **_E**
= Order no. **KDME**
Oak structure nature finish / Silk gloss white

NL

Front / corpus hebben dezelfde kleur als standaard.
Er kunnen ook andere varianten worden gekozen.
De prijsbasis is de prijsgroep van de corpus.
Voorbeeld programma 2060

Front Afwerking eiken structuur natuur **KDM_**
Corpus Zijdeglans wit **_E**
= Ordernummer **KDME**
Afwerking eiken structuur natuur / Zijdeglans wit

FR

La façade / caisson sont de la même couleur que la norme.
D'autres variantes peuvent également être sélectionnées.
La base de prix est le groupe de prix de la couleur de la caisson.
Exemple de programme 2060

Façade Finition de la structure en chêne **KDM_**
Caisson Blanc brillant feuille **_E**
= Numéro d'ordre **KDME**
Finition de la structure en chêne / Blanc brillant feuille

OPTIpremio **light** 2510clarus





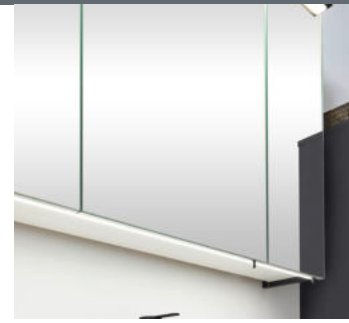
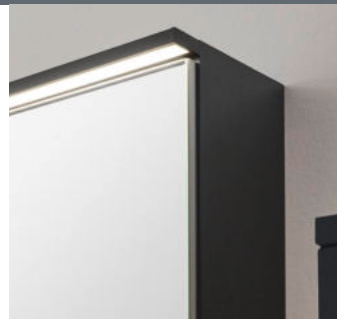

RRK

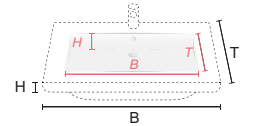

KWRTM8 | 82,0 x 2,0 x 47,0 cm
B x H x T | 44,0 x 11,5 x 26,0 cm

B = Breite / width / breedte / largeur
H = Höhe / height / hoogte / hauteur
T = Tiefe / depth / diepte / profondeur



Weiß Alpin Glanz
gloss white alpine
wit alpine glans
alpin blanc brillant

KWRTM10 | 102,0 x 2,0 x 47,0 cm
B x H x T | 50,0 x 11,5 x 26,0 cm



KWRTM12D | 122,0 x 2,0 x 47,0 cm
B x H x T | 41,0 x 11,5 x 26,0 cm

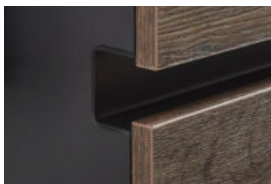

Griffleiste Schwarz matt Struktur
handle strip black matt structure
greeplijst zwart mat structuur
poignée noire matte structure

Front / front / front / façade



Weiß Supermatt
white super matt
wit supermatt
blanc super mat
RRP_



Schwarz Supermatt*
black super matt
zwart supermatt
noir super mat
RRS_



Eiche Struktur Natur Nb.
oak structure nature finish
afwerking eiken struct. natuur
finition chêne naturel structure
RRM_



Eiche Struktur Weiß Nb.
oak structure white finish
afwerking eiken structuur wit
finition chêne blanc structure
RRL_



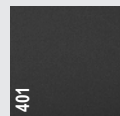

Eiche Struktur Braun Nb.
oak structure brown finish
afwerking eiken structuur bruin
finition chêne brun structure
RRH_

Korpus / carcass outside / corps / caisson



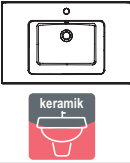
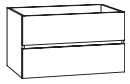
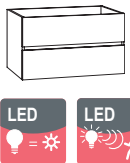
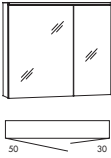





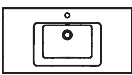

Schwarz Supermatt
black super matt
zwart supermatt
noir super mat
_S (RR25) - PG1

	Maße dimension afmetingen dimensions	B = Breite / width / breedte / largeur cm H = Höhe / height / hoogte / hauteur cm T = Tiefe / depth / diepte / profondeur cm				Artikel-Nr. article-no. artikel nr. article n°.	PG1
		DE	EN	NL	FR		
	B = 82,0 cm H = 2,0 cm T = 47,0 cm	Keramik-Waschtisch inkl. Überlauf	ceramic washbasin incl. overflow	keramische wastafel incl. overloop	lavabo en céramique avec trop-plein	KWRM8	320,-
	B = 80,0 cm H = 47,8 cm T = 46,0 cm	Waschtisch-Unterschrank 1 Schubkasten 1 Auszug	washbasin base cabinet 1 drawer 1 pull-out	wastafelonderkast 1 lade 1 uittrekbaar	armoire de base du lavabo 1 tiroir 1 coulissant	BWKDSA8	770,-
	B = 80,0 cm H = 47,8 cm T = 46,0 cm	Waschtisch-Unterschrank 1 Schubkasten 1 Auszug mit LED-Beleuchtung und Bewegungssensor 4000 K, 3,6 W, 264 Lumen, EEC F	washbasin base cabinet 1 drawer 1 pull-out with LED lighting and motion sensor 4000 K, 3,6 W, 264 lumen, EEC F	wastafelonderkast 1 lade 1 uittrekbaar met LED-verlichting en bewegingssensor 4000 K, 3,6 W, 264 lumen, EEC F	armoire de base du lavabo 1 tiroir 1 coulissant avec éclairage LED et sérénité des mouve- ments 4000 K, 3,6 W, 264 lumens, EEC F	BWKDSAL8	1080,-
	B = 80,0 cm H = 69,6 cm T = 17,6 cm	Spiegelschrank, 2 beidseitig verspiegelte Türen, 2 Glaseinlegeböden, inkl. Schalter/Steckdose	mirror cabinet, 2 doors mirrored on both sides, 2 glass shelves, incl. switch/socket	spiegelkast, 2 deuren gespiegeld aan beide zijden, 2 glazen leggers, incl. schakelaar/stopcontact	armoire de toilette, 2 portes avec miroir des deux côtés, 2 tablettes en verre, avec interrupteur/ prise de courant		
		Türaufteilung door division deurdivisie division des portes	Beleuchtung lighting verlichting éclairage		Leistung performance prestaties performance	Artikel-Nr. article-no. artikel nr. article n°.	
		50 / 30	LED-Aufbauleuchte, integriert LED-top light, integrated LED-opbouwlamp, geïntegreerd lampe LED de surface, intégré		4000 K, 7,7 W, 840 Lumen	SLWA8L	730,-
			LED-Unterbauleuchte, integriert LED under-cabinet light, integrated onderbouwlamp LED, geïntegreerd luminaire d'agencement à LED, intégré		4000 K, 7,5 W, 1050 Lumen Dieses Produkt enthält Lichtquellen der Energieeffizienzklasse F		

Leuchtmittel sind nicht austauschbar / illuminants are not interchangeable / verlichtingsmiddelen zijn niet uitwisselbaar / les illuminants ne sont pas interchangeables
 Mehrpreis Powerbox CH/FR Seite 41 / surcharge powerbox CH/FR page 41 / meerprijs powerbox CH/FR pag.41 / surcôté powerbox CH/FR page 41.

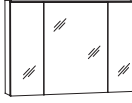
Unverbindlich empfohlene VK-Preise inkl. MwSt. / recommended sales prices incl. VAT / aanbevolen verkoopprijzen inclusief BTW / prix de vente recommandés, TVA inclus



	Maße dimension afmetingen dimensions	B = Breite / width / breedte / largeur cm H = Höhe / height / hoogte / hauteur cm T = Tiefe / depth / diepte / profondeur cm				Artikel-Nr. article-no. artikel nr. article n°.	PG1
		DE	EN	NL	FR		
 	B = 102,0 cm H = 2,0 cm T = 47,0 cm	Keramik-Waschtisch inkl. Überlauf	ceramic washbasin incl. overflow	keramische wastafel incl. overflow	lavabo en céramique avec trop-plein	KWRM10	400,-
	B = 100,0 cm H = 47,8 cm T = 46,0 cm	Waschtisch-Unterschrank 1 Schubkasten 1 Auszug	washbasin base cabinet 1 drawer 1 pull-out	wastafelonderkast 1 lade 1 uittrekbaar	armoire de base du lavabo 1 tiroir 1 coulissant	BWKDSA10	850,-
  	B = 100,0 cm H = 47,8 cm T = 46,0 cm	Waschtisch-Unterschrank 1 Schubkasten 1 Auszug mit LED-Beleuchtung und Bewegungssensor 4000 K, 4,6 W, 334 Lumen, EEC F	washbasin base cabinet 1 drawer 1 pull-out with LED lighting and motion sensor 4000 K, 4,6 W, 334 lumen, EEC F	wastafelonderkast 1 lade 1 uittrekbaar met LED-verlichting en bewegingssensor 4000 K, 4,6 W, 334 lumen, EEC F	armoire de base du lavabo 1 tiroir 1 coulissant avec éclairage LED et sérénité des mou- vements 4000 K, 4,6 W, 334 lumens, EEC F	BWKDSAL10	1200,-
  	B = 100,0 cm H = 69,6 cm T = 17,6 cm	Spiegelschrank, 3 Spiegeltüren 6 Glaseinlegeböden, inkl. Schalter/Steckdose	mirror cabinet, 3 mirror doors, 6 glass shelves, incl. switch/socket	spiegelkast, 3 spiegeldeuren, 6 glazen leggers, incl. schakelaar/stopcontact	armoire de toilette, 3 portes en miroir, 6 tablettes en verre, avec interrupteur/prise de courant		
		Türaufteilung door division deurdivisie division des portes	Beleuchtung lighting verlichting éclairage	Leistung performance prestaties performance	Artikel-Nr. article-no. artikel nr. article n°.		
		25 / 50 / 25	LED-Aufbauleuchte, integriert LED-top light, integrated LED-opbouwlamp, geïntegreerd lampe LED de surface, intégré	4000 K, 9,6 W, 1050 Lumen	SLWA10	800,-	
			LED-Unterbauleuchte, integriert LED under-cabinet light, integrated Onderbouwlamp LED, geïntegreerd luminaire d'agencement à LED, intégré	4000 K, 9,5 W, 1330 Lumen			
				Dieses Produkt enthält Lichtquellen der Energieeffizienzklasse F			



Leuchtmittel sind nicht austauschbar / illuminants are not interchangeable / verlichtingsmiddelen zijn niet uitwisselbaar / les illuminants ne sont pas interchangeables

Mehrpreis Powerbox CH/FR Seite 41 / surcharge powerbox CH/FR page 41 / meerprijs powerbox CH/FR pag.41 / surcoût powerbox CH/FR page 41.

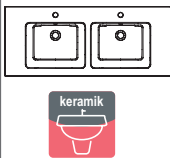

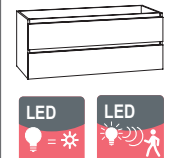

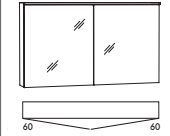

Unverbindlich empfohlene VK-Preise inkl. MwSt. / recommended sales prices incl. VAT / aanbevolen verkoopprijzen inclusief BTW / prix de vente recommandés, TVA inclus

Maße dimension afmetingen dimensions	B = Breite / width / breedte / largeur cm H = Höhe / height / hoogte / hauteur cm T = Tiefe / depth / diepte / profondeur cm				Artikel-Nr. article-no. artikel nr. article n°.	Tür door deur porte	PG1
	DE	EN	NL	FR			

	B = 122,0 cm H = 2,0 cm T = 47,0 cm	Keramik-Waschtisch inkl. Überlauf	ceramic washbasin incl. overflow	keramische wastafel incl. overloop	lavabo en céramique avec trop-plein	KWRM12D		520,-
	B = 120,0 cm H = 47,8 cm T = 46,0 cm	Waschtisch-Unterschrank 1 Schubkasten 1 Auszug	washbasin base cabinet 1 drawer 1 pull-out	wastafelonderkast 1 lade 1 uittrekbaar	armoie de base du lavabo 1 tiroir 1 coulissant	BWKDSA12		920,-
	B = 120,0 cm H = 47,8 cm T = 46,0 cm	Waschtisch-Unterschrank 1 Schubkasten 1 Auszug mit LED-Beleuchtung und Bewegungssensor 4000 K, 5,5 W, 404 Lumen, EEC F	washbasin base cabinet 1 drawer 1 pull-out with LED lighting and motion sensor 4000 K, 5,5 W, 404 lumen, EEC F	wastafelonderkast 1 lade 1 uittrekbaar met LED-verlichting en bewegingssensor 4000 K, 5,5 W, 404 lumen, EEC F	armoie de base du lavabo 1 tiroir 1 coulissant avec éclairage LED et sérénité des mouve- ments 4000 K, 5,5 W, 404 lumens, EEC F	BWKDSAL12		1300,-

	B = 120,0 cm H = 69,6 cm T = 17,6 cm	Spiegelschrank, 2 beidseitig verspiegelte Türen, 4 Glaseinlegeböden, inkl. Schalter/Steckdose	mirror cabinet, 2 doors mirrored on both sides, 4 glass shelves, incl. switch/socket	spiegelkast, 2 deuren gespiegeld aan beide zijden, 4 glazen leggers, incl. schakelaar/stopcontact	armoie de toilette, 2 portes avec miroir des deux côtés, 4 tablettes en verre, avec interrupteur/ prise de courant			
		Türaufteilung door division deurdivisie division des portes	Beleuchtung lighting verlichting éclairage	Leistung performance prestaties performance	Artikel-Nr. article-no. artikel nr. article n°.			
		60 / 60	LED-Aufbauleuchte, integriert LED-top light, integrated LED-opbouwlamp, geïntegreerd lampe LED de surface, intégré LED-Unterbauleuchte, integriert LED under-cabinet light, integrated onderbouwlamp LED, geïntegreerd luminaire d'agencement à LED, intégré	4000 K, 11,5 W, 1260 Lumen 4000 K, 11,5 W, 1610 Lumen Dieses Produkt enthält Lichtquellen der Energieeffizienzklasse F	SLWA12D		950,-	

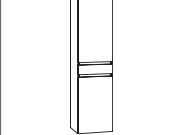
Beistellschränke | side cabinets | zijkasten | armoires d'appoint

	B = 40,0 cm H = 91,2 cm T = 35,0 cm	Highboard inkl. Abdeck- platte 1 Tür 1 Schubkasten 2 Glaseinlegeböden	highboard incl. top, 1 door 1 drawer 2 glass shelves	highboard incl. afdekplaat, 1 deur 1 lade 2 glazen leggers	highboard avec plaque de recouvrement, 1 porte 1 tiroir 2 tablettes en verre	BHBST4FL BHBST4FR		520,- 520,-
	B = 40,0 cm H = 148,8 cm T = 35,0 cm	Mittelschrank inkl. Ab- deckplatte 2 Türen 1 Schubkasten 3 Glaseinlegeböden	medium cabinet incl. top 2 doors 1 drawer 3 glass shelves	middelgrote kast incl. afdekplaat 2 deuren 1 lade 3 glazen leggers	armoie moyenne avec plaque de recouvrement, 2 portes 1 tiroir 3 tablettes en verre	BMTST4FL BMTST4FR		760,- 760,-
	B = 40,0 cm H = 178,7 cm T = 35,0 cm	Hochschrank, 2 Türen 1 Schubkasten 3 Glaseinlegeböden	tower cabinet, 2 doors 1 drawer 3 glass shelves	hoge kast 2 deuren 1 lade 3 glazen leggers	armoires haute 2 portes 1 tiroir 3 tablettes en verre	BHTST4L BHTST4R		800,- 800,-

Zubehör | accessories | toebehoren | accessoires

☞ mehr ab Seite / more from page / meer van pagina / plus de la page 40

	B = 33,7 cm H = 4,3 cm T = 28,0 cm	Schubkasteneinsatz (Kunststoff) für oberen Auszug vom Waschtisch- Unterschrank	drawer insert (plastic) for upper drawer from the WT base cabinet	lade inzetstuk (kunststof) voor bovenste lade van de WC-basis- eenheid	bloc-tiroir (plastique) pour tiroir supérieur coulissant de l'élément bas WT	SMBEG3		31,-
--	--	---	---	---	---	--------	--	------

Leuchtmittel sind nicht austauschbar / illuminants are not interchangeable / verlichtingsmiddelen zijn niet uitwisselbaar / les illuminants ne sont pas interchangeables
Mehrpreis Powerbox CH/FR Seite 41 / surcharge powerbox CH/FR page 41 / meerprijs powerbox CH/FR pag.41 / surcoût powerbox CH/FR page 41.

Unverbindlich empfohlene VK-Preise inkl. MwSt. / recommended sales prices incl. VAT / aanbevolen verkoopprijzen inclusief BTW / prix de vente recommandés, TVA inclus

OPTIpremio **light** 2500maxus







Weiß Alpin Glanz
gloss white alpine
wit alpine glans
alpin blanc brillant



One-Cubic

GRK

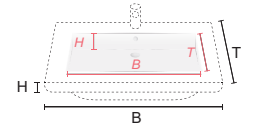

B = Breite / width / breedte / largeur
H = Höhe / height / hoogte / hauteur
T = Tiefe / depth / diepte / profondeur

KWHER6 | 60,0 x 14,0 x 42,0 cm
B x H x T | 56,0 x 10,0 x 28,0 cm



One-Round

Olive



KWONE4 | 42,0 x 14,0 x 42,0 cm
B x H x T | 38,0 x 11,5 x 28,0 cm

KWOLI75 | 74,0 x 14,5 x 38,5 cm
B x H x T | 64,0 x 12,0 x 34,0 cm



Rumba

GRK Weiß Glanz
white gloss
wit glans
blanc brillant

GRKB Schwarz Matt
black matt
zwart mat
noir mat

KWAWG6 | 61,2 x 12,0 x 46,6 cm
B x H x T | 59,6 x 9,9 x 32,7 cm

Farben Waschtischplatten, Tischgestelle und Korpus Spiegelschrank

colours washbasin tops, table frames and carcass mirror cabinet
kleuren wastafelbladen, tafellijsten en corpus spiegelkast
couleurs plateaux de lavabo, bâtis de table et corps de l'armoire de toilette



Eiche Struktur Natur Nb.
oak structure nature finish
afwerking eiken struct. natuur
finition chêne naturel structure
GR55



Schwarz Supermatt
black super matt
zwart supermatt
noir super mat
GR25



Griffeiste Aluminium Matt
handle strip aluminium matt
greeplijst aluminium mat
poignée en aluminium mat

Front / front / front / façade



Weiß Supermatt
white super matt
wit supermatt
blanc super mat
GRP_



Schwarz Supermatt*
black super matt
zwart supermatt
noir super mat
GRS_



Eiche Struktur Natur Nb.
oak structure nature finish
afwerking eiken struct. natuur
finition chêne naturel structure
GRM_



Eiche Struktur Weiß Nb.
oak structure white finish
afwerking eiken structuur wit
finition chêne blanc structure
GRL_

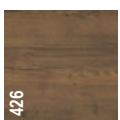

Eiche Struktur Braun Nb.
oak structure brown finish
afwerking eiken structuur bruin
finition chêne brun structure
GRH_

Korpus / carcass outside / corpus / caisson

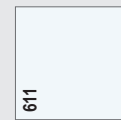

Weiß Supermatt
white super matt
wit supermatt
blanc super mat
_P -PG 1

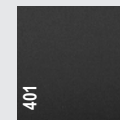

Schwarz Supermatt
black super matt
zwart supermatt
noir super mat
_S -PG 1

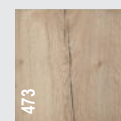

Eiche Struktur Natur Nb.
oak structure nature finish
afwerking eiken struct. natuur
finition chêne naturel structure
_M -PG 1

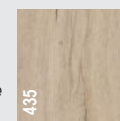



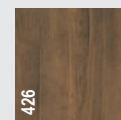













Eiche Struktur Weiß Nb.
oak structure white finish
afwerking eiken structuur wit
finition chêne blanc structure
_L -PG 1



















Eiche Struktur Braun Nb.
oak structure brown finish
afwerking eiken structuur bruin
finition chêne brun structure
_H -PG 1

OPTI premio light 2500maxus

 One-Cubic	Maße dimension afmetingen dimensions	B = Breite / width / breedte / largeur cm H = Höhe / height / hoogte / hauteur cm T = Tiefe / depth / diepte / profondeur cm				Artikel-Nr. article-no. artikel nr. article n°.	PG1
		DE	EN	NL	FR		
 	B = 100,4 cm H = 77,0 cm/ 92,9 cm T = 48,5 cm	Set 100 cm bestehend aus: - Aufsatz-Keramik-Waschtisch One-Cubic - Waschtischplatte 19mm Eiche Str. Natur Nb. - Waschtischunterschrank 1 Schubkasten, 1 Auszug, 2 offene Fächer incl. Glas-einlegeboden - Tischgestell Eiche Str. Natur Nb.	set 100 cm consisting of: - top ceramic washbasin One-Cubic - washbasin top 19mm oak str. natur finish - base unit 1 drawer, 1 pull-out, 2 open compartments incl. glass shelf - table frame oak str. natur finish	set 100 cm bestaande uit: - top keramische wastafel One-Cubic - wastafelblad 19mm eiken str. natur - wastafelonderkast 1 lade, 1 uittrekbaar, 2 open vakken incl. glazen legger - tafelframe eiken str. natur afwerking	set 100 cm composé de : - lavabo à poser en céramique One-Cubic plan de lavabo 19mm chêne str. natur armoire de base du lavabo 1 tiroir, 1 coulissant, 2 compartiments ouverts avec tablettes en verre - cadre de table chêne massif, finition naturelle	GHSA10HM  	1870,-
 	B = 100,4 cm H = 77,0 cm/ 92,9 cm T = 48,5 cm	Set 100 cm bestehend aus: - Aufsatz-Keramik-Waschtisch One-Cubic - Waschtischplatte 19mm Schwarz Supermatt - Waschtischunterschrank 1 Schubkasten, 1 Auszug, 2 offene Fächer incl. Glas-einlegeboden - Tischgestell Schwarz Supermatt	set 100 cm consisting of: - top ceramic washbasin One-Cubic - washbasin top 19mm black supermatt - base unit 1 drawer, 1 pull-out, 2 open compartments incl. glass shelf - table frame black supermatt	set 100 cm bestaande uit: - top keramische wastafel One-Cubic - wastafelblad 19mm zwarte supermatt - wastafelonderkast 1 lade, 1 uittrekbaar, 2 open vakken incl. glazen legger - tafelframe zwarte supermatt	set 100 cm composé de : - lavabo à poser en céramique One-Cubic plan de lavabo 19mm noir supermatt armoire de base du lavabo 1 tiroir, 1 coulissant, 2 compartiments ouverts avec tablettes en verre - cadre de table noir supermatt	GHSA10HS  	1990,-
 	B = 120,4 cm H = 77,0 cm/ 92,9 cm T = 48,5 cm	Set 120 cm bestehend aus: - Aufsatz-Keramik-Waschtisch One-Cubic - Waschtischplatte 19mm Eiche Str. Natur Nb. - Waschtischunterschrank 1 Schubkasten, 1 Auszug, 2 offene Fächer incl. Glas-einlegeboden - Tischgestell Eiche Str. Natur Nb.	set 120 cm consisting of: - top ceramic washbasin One-Cubic - washbasin top 19mm oak str. natur finish - base unit 1 drawer, 1 pull-out, 2 open compartments incl. glass shelf - table frame oak str. natur finish	set 120 cm bestaande uit: - top keramische wastafel One-Cubic - wastafelblad 19mm eiken str. natur - wastafelonderkast 1 lade, 1 uittrekbaar, 2 open vakken incl. glazen legger - tafelframe eiken str. natur afwerking	set 120 cm composé de : - lavabo à poser en céramique One-Cubic plan de lavabo 19mm chêne str. natur armoire de base du lavabo 1 tiroir, 1 coulissant, 2 compartiments ouverts avec tablettes en verre - cadre de table chêne massif, finition naturelle	GHSA12HM  	1980,-
 	B = 120,4 cm H = 77,0 cm/ 92,9 cm T = 48,5 cm	Set 120 cm bestehend aus: - Aufsatz-Keramik-Waschtisch One-Cubic - Waschtischplatte 19mm Schwarz Supermatt - Waschtischunterschrank 1 Schubkasten, 1 Auszug, 2 offene Fächer incl. Glas-einlegeboden - Tischgestell Schwarz Supermatt	set 120 cm consisting of: - top ceramic washbasin One-Cubic - washbasin top 19mm black supermatt - base unit 1 drawer, 1 pull-out, 2 open compartments incl. glass shelf - table frame black supermatt	set 120 cm bestaande uit: - top keramische wastafel One-Cubic - wastafelblad 19mm zwarte supermatt - wastafelonderkast 1 lade, 1 uittrekbaar, 2 open vakken incl. glazen legger - tafelframe zwarte supermatt	set 120 cm composé de : - lavabo à poser en céramique One-Cubic plan de lavabo 19mm noir supermatt armoire de base du lavabo 1 tiroir, 1 coulissant, 2 compartiments ouverts avec tablettes en verre - cadre de table noir supermatt	GHSA12HS  	2130,-



















Der Waschtisch One-Cubic wird inkl. Permanentablauf in Fb. Chrom geliefert. Anschluß durch Kunden. The One-Cubic washbasin is supplied with a permanent drain in col. chrome. Installation by customer. De One-Cubic wastafel wordt geleverd met een vaste afvoer in chroom. Aansluiting door klant. Le lavabo One-Cubic est livré avec une bonde permanente de couleur chrome. Raccordement par le client. Unverbindlich empfohlene VK-Preise inkl. MwSt. / recommended sales prices incl. VAT / aanbevolen verkoopprijzen inclusief BTW / prix de vente recommandés, TVA inclus

OPTI premio light 2500maxus















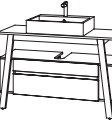

 One-Round	Maße dimension afmetingen dimensions	B = Breite / width / breedte / largeur cm H = Höhe / height / hoogte / hauteur cm T = Tiefe / depth / diepte / profondeur cm				Artikel-Nr. article-no. artikel nr. article n°.	PG1
		DE	EN	NL	FR		
 	B = 100,4 cm H = 77,0 cm/ 92,9 cm T = 48,5 cm	Set 100 cm bestehend aus: - Aufsatz-Keramik-Waschtisch One-Round - Waschtischplatte 19mm Eiche Str. Natur Nb. - Waschtischunterschrank 1 Schubkasten, 1 Auszug, 2 offene Fächer incl. Glas- einlegeboden - Tischgestell Eiche Str. Natur Nb.	set 100 cm consisting of: - top ceramic washbasin One-Round - washbasin top 19mm oak str. natur finish - base unit 1 drawer, 1 pull-out, 2 open compartments incl. glass shelf - table frame oak str. natur finish	set 100 cm bestaande uit: - top keramische wastafel One-Round - wastafelblad 19mm eiken str. natur - wastafelonderkast 1 lade, 1 uittrekbaar, 2 open vakken incl. glazen legger - tafelframe eiken str. natur afwerking	set 100 cm composé de : - lavabo à poser en céramique One-Round plan de lavabo 19mm chêne str. natur armoire de base du lavabo 1 tiroir, 1 coulissant, 2 compartiments ouverts avec tablettes en verre - cadre de table chêne massif, finition naturelle	GHSA10NM  	1720,-
 	B = 100,4 cm H = 77,0 cm/ 92,9 cm T = 48,5 cm	Set 100 cm bestehend aus: - Aufsatz-Keramik-Waschtisch One-Round - Waschtischplatte 19mm Schwarz Supermatt - Waschtischunterschrank 1 Schubkasten, 1 Auszug, 2 offene Fächer incl. Glas- einlegeboden - Tischgestell Schwarz Supermatt	set 100 cm consisting of: - top ceramic washbasin One-Round - washbasin top 19mm black supermatt - base unit 1 drawer, 1 pull-out, 2 open compartments incl. glass shel - table frame black supermatt	set 100 cm bestaande uit: - top keramische wastafel One-Round - wastafelblad 19mm zwarte supermatt - wastafelonderkast 1 lade, 1 uittrekbaar, 2 open vakken incl. glazen legger - tafelframe zwarte supermatt	set 100 cm composé de : - lavabo à poser en céramique One-Round plan de lavabo 19mm noir supermatt armoire de base du lavabo 1 tiroir, 1 coulissant, 2 compartiments ouverts avec tablettes en verre - cadre de table noir supermatt	GHSA10NS  	1840,-
 	B = 120,4 cm H = 77,0 cm/ 92,9 cm T = 48,5 cm	Set 120 cm bestehend aus: - Aufsatz-Keramik-Waschtisch One-Round - Waschtischplatte 19mm Eiche Str. Natur Nb. - Waschtischunterschrank 1 Schubkasten, 1 Auszug, 2 offene Fächer incl. Glas- einlegeboden - Tischgestell Eiche Str. Natur Nb.	set 120 cm consisting of: - top ceramic washbasin One-Round - washbasin top 19mm oak str. natur finish - base unit 1 drawer, 1 pull-out, 2 open compartments incl. glass shelf - table frame oak str. natur finish	set 120 cm bestaande uit: - top keramische wastafel One-Round - wastafelblad 19mm eiken str. natur - wastafelonderkast 1 lade, 1 uittrekbaar, 2 open vakken incl. glazen legger - tafelframe eiken str. natur afwerking	set 120 cm composé de : - lavabo à poser en céramique One-Round plan de lavabo 19mm chêne str. natur armoire de base du lavabo 1 tiroir, 1 coulissant, 2 compartiments ouverts avec tablettes en verre - cadre de table chêne massif, finition naturelle	GHSA12NM  	1830,-
 	B = 120,4 cm H = 77,0 cm/ 92,9 cm T = 48,5 cm	Set 120 cm bestehend aus: - Aufsatz-Keramik-Waschtisch One-Round - Waschtischplatte 19mm Schwarz Supermatt - Waschtischunterschrank 1 Schubkasten, 1 Auszug, 2 offene Fächer incl. Glas- einlegeboden - Tischgestell Schwarz Supermatt	set 120 cm consisting of: - top ceramic washbasin One-Round - washbasin top 19mm black supermatt - base unit 1 drawer, 1 pull-out, 2 open compartments incl. glass shelf - table frame black supermatt	set 120 cm bestaande uit: - top keramische wastafel One-Round - wastafelblad 19mm zwarte supermatt - wastafelonderkast 1 lade, 1 uittrekbaar, 2 open vakken incl. glazen legger - tafelframe zwarte supermatt	set 120 cm composé de : - lavabo à poser en céramique One-Round plan de lavabo 19mm noir supermatt armoire de base du lavabo 1 tiroir, 1 coulissant, 2 compartiments ouverts avec tablettes en verre - cadre de table noir supermatt	GHSA12NS  	1980,-

Der Waschtisch One-Round wird inkl. Permanentablauf in Fb. Chrom geliefert. Anschluß durch Kunden. The One-Round washbasin is supplied with a permanent drain in col. chrome. Installation by custom. De One-Round wastafel wordt geleverd met een vaste afvoer in chroom. Aansluiting door klant. Le lavabo One-Round est livré avec une bonde permanente de couleur chrome. Raccordement par le client. Unverbindlich empfohlene VK-Preise inkl. MwSt. / recommended sales prices incl. VAT / aanbevolen verkoopprijzen inclusief BTW / prix de vente recommandés, TVA inclus

OPTI premio light 2500maxus

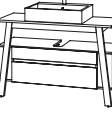













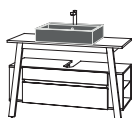

 <p>Olive</p>	<p>Maße dimension afmetingen dimensions</p>	<p>B = Breite / <i>width</i> / <i>breedte</i> / <i>largeur</i> cm H = Höhe / <i>height</i> / <i>hoogte</i> / <i>hauteur</i> cm T = Tiefe / <i>depth</i> / <i>diepte</i> / <i>profondeur</i> cm</p>				<p>Artikel-Nr. article-no. artikel nr. article n°.</p>	<p>PG1</p>
		DE	EN	NL	FR		
 	<p>B = 100,0 cm H = 77,0 cm / 93,4 cm T = 48,5 cm</p>	<p>Set 100 cm bestehend aus: - Aufsatz-Keramik-Waschtisch Olive - Waschtischplatte 19mm Eiche Str. Natur Nb. - Waschtischunterschrank 1 Schubkasten, 1 Auszug, 2 offene Fächer incl. Glas-einlegeboden - Tischgestell Eiche Str. Natur Nb.</p>	<p>set 100 cm consisting of: - top ceramic washbasin Olive - washbasin top 19mm oak str. natur finish - base unit 1 drawer, 1 pull-out, 2 open compartments incl. glass shelf - table frame oak str. natur finish</p>	<p>set 100 cm bestaande uit: - top keramische wastafel Olive - wastafelblad 19mm eiken str. natur - wastafelonderkast 1 lade, 1 uittrekbaar, 2 open vakken incl. glazen legger - tafelframe eiken str. natur afwerking</p>	<p>set 100 cm composé de : - lavabo à poser en céramique Olive plan de lavabo 19mm chêne str. natur armoire de base du lavabo 1 tiroir, 1 coulissant, 2 compartiments ouverts avec tablettes en verre - cadre de table chêne massif, finition naturelle</p>	<p>GHSA10LM</p>  	<p>1940,-</p>
 	<p>B = 100,0 cm H = 77,0 cm / 93,4 cm T = 48,5 cm</p>	<p>Set 100 cm bestehend aus: - Aufsatz-Keramik-Waschtisch Olive - Waschtischplatte 19mm Schwarz Supermatt - Waschtischunterschrank 1 Schubkasten, 1 Auszug, 2 offene Fächer incl. Glas-einlegeboden - Tischgestell Schwarz Supermatt</p>	<p>set 100 cm consisting of: - top ceramic washbasin Olive - washbasin top 19mm black supermatt - base unit 1 drawer, 1 pull-out, 2 open compartments incl. glass shelf - table frame black supermatt</p>	<p>set 100 cm bestaande uit: - top keramische wastafel Olive - wastafelblad 19mm zwarte supermatt - wastafelonderkast 1 lade, 1 uittrekbaar, 2 open vakken incl. glazen legger - tafelframe zwarte supermatt</p>	<p>set 100 cm composé de : - lavabo à poser en céramique Olive plan de lavabo 19mm noir supermatt armoire de base du lavabo 1 tiroir, 1 coulissant, 2 compartiments ouverts avec tablettes en verre - cadre de table noir supermatt</p>	<p>GHSA10LS</p>  	<p>2060,-</p>
 	<p>B = 120,0 cm H = 77,0 cm / 93,4 cm T = 48,5 cm</p>	<p>Set 120 cm bestehend aus: - Aufsatz-Keramik-Waschtisch Olive - Waschtischplatte 19mm Eiche Str. Natur Nb. - Waschtischunterschrank 1 Schubkasten, 1 Auszug, 2 offene Fächer incl. Glas-einlegeboden - Tischgestell Eiche Str. Natur Nb.</p>	<p>set 120 cm consisting of: - top ceramic washbasin Olive - washbasin top 19mm oak str. natur finish - base unit 1 drawer, 1 pull-out, 2 open compartments incl. glass shelf - table frame oak str. natur finish</p>	<p>set 120 cm bestaande uit: - top keramische wastafel Olive - wastafelblad 19mm eiken str. natur - wastafelonderkast 1 lade, 1 uittrekbaar, 2 open vakken incl. glazen legger - tafelframe eiken str. natur afwerking</p>	<p>set 120 cm composé de : - lavabo à poser en céramique Olive plan de lavabo 19mm chêne str. natur armoire de base du lavabo 1 tiroir, 1 coulissant, 2 compartiments ouverts avec tablettes en verre - cadre de table chêne massif, finition naturelle</p>	<p>GHSA12LM</p>  	<p>2050,-</p>
 	<p>B = 120,0 cm H = 77,0 cm / 93,4 cm T = 48,5 cm</p>	<p>Set 120 cm bestehend aus: - Aufsatz-Keramik-Waschtisch Olive - Waschtischplatte 19mm Schwarz Supermatt - Waschtischunterschrank 1 Schubkasten, 1 Auszug, 2 offene Fächer incl. Glas-einlegeboden - Tischgestell Schwarz Supermatt</p>	<p>set 120 cm consisting of: - top ceramic washbasin Olive - washbasin top 19mm black supermatt - base unit 1 drawer, 1 pull-out, 2 open compartments incl. glass shelf - table frame black supermatt</p>	<p>set 120 cm bestaande uit: - top keramische wastafel Olive - wastafelblad 19mm zwarte supermatt - wastafelonderkast 1 lade, 1 uittrekbaar, 2 open vakken incl. glazen legger - tafelframe zwarte supermatt</p>	<p>set 120 cm composé de : - lavabo à poser en céramique Olive plan de lavabo 19mm noir supermatt armoire de base du lavabo 1 tiroir, 1 coulissant, 2 compartiments ouverts avec tablettes en verre - cadre de table noir supermatt</p>	<p>GHSA12LS</p>  	<p>2200,-</p>
<p>Der Waschtisch Olive wird inkl. Permanentablauf in Fb. Chrom geliefert. Anschluß durch Kunden. Es wird eine Stand- oder Wandarmatur benötigt. The Olive washbasin is supplied with a permanent drain in col. chrome. Installation by customer. A floor-standing or wall-mounted fitting is required. De Olive wastafel wordt geleverd met een vaste afvoer in chroom. Aansluiting door klant. Een vloer- of wandmontage is vereist. Le lavabo Olive est livré avec une bonde permanente de couleur chrome. Raccordement par le client. Une robinetterie sur pied ou murale est nécessaire.</p>							
	<p>Stand Waschtischarmatur (nur für 2500 Waschtisch Olive), inkl. Zugstange und Montagematerial</p>		<p>stand washbasin tap (only for 2500 washbasin Olive), incl. pull rod and fixing material</p>	<p>staande wastafelkraan (alleen voor 2500 wastafel Olive), incl. trekstang en bevestigingsmateriaal</p>	<p>robinetterie de lavabo au sol (seulement pour 2500 lavabo Olive), avec tige de traction et matériel de fixation</p>	<p>MBCE MBSK</p>	<p>310,- 400,-</p>
<p>Unverbindlich empfohlene VK-Preise inkl. MwSt. / recommended sales prices incl. VAT / aanbevolen verkoopprijzen inclusief BTW / prix de vente recommandés, TVA inclus</p>							

OPTI premio **light** 2500maxus

 Rumba	Maße dimension afmetingen dimensions	B = Breite / width / breedte / largeur cm H = Höhe / height / hoogte / hauteur cm T = Tiefe / depth / diepte / profondeur cm				Artikel-Nr. article-no. artikel nr. article n°.	PG1
		DE	EN	NL	FR		
 	B = 100,4 cm H = 77,0 cm/ 91,0 cm T = 48,5 cm	Set 100 cm bestehend aus: - Aufsatz-Keramik-Waschtisch Rumba weiß Glanz - Waschtischplatte 19mm Eiche Str. Natur Nb. - Waschtischunterschrank 1 Schubkasten, 1 Auszug, 2 offene Fächer incl. Glas- einlegeboden - Tischgestell Eiche Str. Natur Nb.	set 100 cm consisting of: - top ceramic washbasin Rumba gloss white - washbasin top 19mm oak str. natur finish - base unit 1 drawer, 1 pull-out, 2 open compartments incl. glass shelf - table frame oak str. natur finish	set 100 cm bestaande uit: - top keramische wastafel Rumba witte glans - wastafelblad 19mm eiken str. natur - wastafelonderkast 1 lade, 1 uittrekbaar, 2 open vakken incl. glazen legger - tafelframe eiken str. natur afwerking	set 100 cm composé de : - lavabo à poser en céra. Rumba blanc brillant plan de lavabo 19mm chêne str. natur armoire de base du lavabo 1 tiroir, 1 coulissant, 2 compartiments ouverts avec tablettes en verre - cadre de table chêne massif, finition naturelle	GHSA10AM  	1680,-
 	B = 100,4 cm H = 77,0 cm/ 91,0 cm T = 48,5 cm	Set 100 cm bestehend aus: - Aufsatz-Keramik-Waschtisch Rumba weiß Glanz - Waschtischplatte 19mm Schwarz Supermatt - Waschtischunterschrank 1 Schubkasten, 1 Auszug, 2 offene Fächer incl. Glas- einlegeboden - Tischgestell Schwarz Supermatt	set 100 cm consisting of: - top ceramic washbasin Rumba gloss white - washbasin top 19mm black supermatt - base unit 1 drawer, 1 pull-out, 2 open compartments incl. glass shelf - table frame black supermatt	set 100 cm bestaande uit: - top keramische wastafel Rumba witte glans - wastafelblad 19mm zwarte supermatt - wastafelonderkast 1 lade, 1 uittrekbaar, 2 open vakken incl. glazen legger - tafelframe zwarte supermatt	set 100 cm composé de : - lavabo à poser en céra. Rumba blanc brillant plan de lavabo 19mm noir supermatt armoire de base du lavabo 1 tiroir, 1 coulissant, 2 compartiments ouverts avec tablettes en verre - cadre de table noir supermatt	GHSA10AS  	1800,-
 	B = 120,4 cm H = 77,0 cm/ 91,0 cm T = 48,5 cm	Set 120 cm bestehend aus: - Aufsatz-Keramik-Waschtisch Rumba weiß Glanz - Waschtischplatte 19mm Eiche Str. Natur Nb. - Waschtischunterschrank 1 Schubkasten, 1 Auszug, 2 offene Fächer incl. Glas- einlegeboden - Tischgestell Eiche Str. Natur Nb.	set 120 cm consisting of: - top ceramic washbasin Rumba gloss white - washbasin top 19mm oak str. natur finish - base unit 1 drawer, 1 pull-out, 2 open compartments incl. glass shelf - table frame PG1 oak str. natur finish	set 120 cm bestaande uit: - top keramische wastafel Rumba witte glans - wastafelblad 19mm eiken str. natur - wastafelonderkast 1 lade, 1 uittrekbaar, 2 open vakken incl. glazen legger - tafelframe eiken str. natur afwerking	set 120 cm composé de : - lavabo à poser en céra. Rumba blanc brillant plan de lavabo 19mm chêne str. natur armoire de base du lavabo 1 tiroir, 1 coulissant, 2 compartiments ouverts avec tablettes en verre - cadre de table chêne massif, finition naturelle	GHSA12AM  	1790,-
 	B = 120,4 cm H = 77,0 cm/ 91,0 cm T = 48,5 cm	Set 120 cm bestehend aus: - Aufsatz-Keramik-Waschtisch Rumba weiß Glanz - Waschtischplatte 19mm Schwarz Supermatt - Waschtischunterschrank 1 Schubkasten, 1 Auszug, 2 offene Fächer incl. Glas- einlegeboden - Tischgestell Schwarz Supermatt	set 120 cm consisting of: - top ceramic washbasin Rumba gloss white - washbasin top 19mm black supermatt - base unit 1 drawer, 1 pull-out, 2 open compartments incl. glass shelf - table frame black supermatt	set 120 cm bestaande uit: - top keramische wastafel Rumba witte glans - wastafelblad 19mm zwarte supermatt - wastafelonderkast 1 lade, 1 uittrekbaar, 2 open vakken incl. glazen legger - tafelframe zwarte supermatt	set 120 cm composé de : - lavabo à poser en céra. Rumba blanc brillant plan de lavabo 19mm noir supermatt armoire de base du lavabo 1 tiroir, 1 coulissant, 2 compartiments ouverts avec tablettes en verre - cadre de table noir supermatt	GHSA12AS  	1940,-

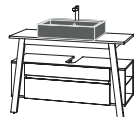







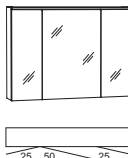

Unverbindlich empfohlene VK-Preise inkl. MwSt. / recommended sales prices incl. VAT / aanbevolen verkoopprijzen inclusief BTW / prix de vente recommandés, TVA inclus

OPTI premio **light** 2500maxus

 Rumba	Maße dimension afmetingen dimensions	B = Breite / <i>width</i> / <i>breedte</i> / <i>largeur</i> cm H = Höhe / <i>height</i> / <i>hoogte</i> / <i>hauteur</i> cm T = Tiefe / <i>depth</i> / <i>diepte</i> / <i>profondeur</i> cm				Artikel-Nr. article-no. artikel nr. article n°.	PG1
		DE	EN	NL	FR		
 	B = 100,4 cm H = 77,0 cm / 91,0 cm T = 48,5 cm	Set 100 cm bestehend aus: - Aufsatz-Keramik-Waschtisch Rumba Schwarz Matt - Waschtischplatte 19mm Eiche Str. Natur Nb. - Waschtischunterschrank 1 Schubkasten, 1 Auszug, 2 offene Fächer incl. Glas-einlegeboden - Tischgestell Eiche Str. Natur Nb.	set 100 cm consisting of: - top ceramic washbasin Rumba black matt - washbasin top 19mm oak str. natur finish - base unit 1 drawer, 1 pull-out, 2 open compartments incl. glass shelf - table frame in oak str. natur finish	set 100 cm bestaande uit: - top keramische wastafel Rumba zwart mat - wastafelblad 19mm eiken str. natur - wastafelonderkast 1 lade, 1 uittrekbaar, 2 open vakken incl. glazen legger - tafelframe eiken str. natur afwerking	set 100 cm composé de : - lavabo à poser en céra. Rumba noir mat plan de lavabo 19mm chêne str. natur armoire de base du lavabo 1 tiroir, 1 coulissant, 2 compartiments ouverts avec tablettes en verre cadre de table chêne massif, finition naturelle	GHSA10AMS  	1800,-
 	B = 100,4 cm H = 77,0 cm / 91,0 cm T = 48,5 cm	Set 100 cm bestehend aus: - Aufsatz-Keramik-Waschtisch Rumba Schwarz Matt - Waschtischplatte 19mm Schwarz Supermatt - Waschtischunterschrank 1 Schubkasten, 1 Auszug, 2 offene Fächer incl. Glas-einlegeboden - Tischgestell Schwarz Supermatt	set 100 cm consisting of: - top ceramic washbasin Rumba black matt - washbasin top 19mm black supermatt - base unit 1 drawer, 1 pull-out, 2 open compartments incl. glass shelf - table frame black supermatt	set 100 cm bestaande uit: - top keramische wastafel Rumba zwart mat - wastafelblad 19mm zwarte supermatt - wastafelonderkast 1 lade, 1 uittrekbaar, 2 open vakken incl. glazen legger - tafelframe zwarte supermatt	set 100 cm composé de : - lavabo à poser en céra. Rumba noir mat plan de lavabo 19mm noir supermatt armoire de base du lavabo 1 tiroir, 1 coulissant, 2 compartiments ouverts avec tablettes en verre cadre de table noir supermatt	GHSA10ASS  	1920,-
 	B = 120,4 cm H = 77,0 cm / 91,0 cm T = 48,5 cm	Set 120 cm bestehend aus: - Aufsatz-Keramik-Waschtisch Rumba Schwarz Matt - Waschtischplatte 19mm Eiche Str. Natur Nb. - Waschtischunterschrank 1 Schubkasten, 1 Auszug, 2 offene Fächer incl. Glas-einlegeboden - Tischgestell Eiche Str. Natur Nb.	set 120 cm consisting of: - top ceramic washbasin Rumba black matt - washbasin top 19mm oak str. natur finish - base unit 1 drawer, 1 pull-out, 2 open compartments incl. glass shelf - table frame oak str. natur finish	set 120 cm bestaande uit: - top keramische wastafel Rumba zwart mat - wastafelblad 19mm eiken str. natur - wastafelonderkast 1 lade, 1 uittrekbaar, 2 open vakken incl. glazen legger - tafelframe eiken str. natur afwerking	set 120 cm composé de : - lavabo à poser en céra. Rumba noir mat plan de lavabo 19mm chêne str. natur armoire de base du lavabo 1 tiroir, 1 coulissant, 2 compartiments ouverts avec tablettes en verre cadre de table chêne massif, finition naturelle	GHSA12AMS  	1910,-
 	B = 120,4 cm H = 77,0 cm / 91,0 cm T = 48,5 cm	Set 120 cm bestehend aus: - Aufsatz-Keramik-Waschtisch Rumba Schwarz Matt - Waschtischplatte 19mm Schwarz Supermatt - Waschtischunterschrank 1 Schubkasten, 1 Auszug, 2 offene Fächer incl. Glas-einlegeboden - Tischgestell Schwarz Supermatt	set 120 cm consisting of: - top ceramic washbasin Rumba black matt - washbasin top 19mm black supermatt - base unit 1 drawer, 1 pull-out, 2 open compartments incl. glass shelf - table frame black supermatt	set 120 cm bestaande uit: - top keramische wastafel Rumba zwart mat - wastafelblad 19mm zwarte supermatt - wastafelonderkast 1 lade, 1 uittrekbaar, 2 open vakken incl. glazen legger - tafelframe zwarte supermatt	set 120 cm composé de : - lavabo à poser en céra. Rumba noir mat plan de lavabo 19mm noir supermatt armoire de base du lavabo 1 tiroir, 1 coulissant, 2 compartiments ouverts avec tablettes en verre cadre de table noir supermatt	GHSA12ASS  	2060,-

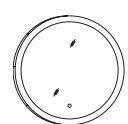
Unverbindlich empfohlene VK-Preise inkl. MwSt. / recommended sales prices incl. VAT / aanbevolen verkoopprijzen inclusief BTW / prix de vente recommandés, TVA inclus

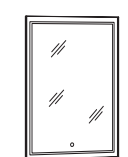
OPTIpremio **light** 2500maxus







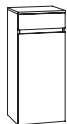

Maße dimension afmetingen dimensions	B = Breite / width / breedte / largeur cm H = Höhe / height / hoogte / hauteur cm T = Tiefe / depth / diepte / profondeur cm				Artikel-Nr. article-no. artikel nr. article n°.		PG1
	DE	EN	NL	FR			
 	B = 100,0 cm H = 69,6 cm T = 17,6 cm	Spiegelschrank, 3 Spiegeltüren 6 Glaseinlegeböden, inkl. Schalter/Steckdose	<i>mirror cabinet, 3 mirror doors, 6 glass shelves, incl. switch/socket</i>	<i>spiegelkast, 3 spiegeldeuren, 6 glazen leggers, incl. schakelaar/stopcontact</i>	<i>armoire de toilette, 3 portes en miroir, 6 tablettes en verre, avec interrupteur/prise de courant</i>		
		Türaufteilung <i>door division deurdivisie division des portes</i>	Beleuchtung <i>lighting verlichting éclairage</i>	Leistung <i>performance prestaties performance</i>	Artikel-Nr. <i>article-no. artikel nr. article n°.</i>		
	25 / 50 / 25	LED-Aufbauleuchte, integriert <i>LED-top light, integrated LED-opbouwlamp, geïntegreerd lampe LED de surface, intégré</i>	4000 K, 9,6 W, 1050 Lumen	SLWB10		680,-	
			Dieses Produkt enthält Lichtquellen der Energieeffizienzklasse F	Korpus / carcase: 	GR55 GR25		
 	B = 120,0 cm H = 69,6 cm T = 17,6 cm	Spiegelschrank, 3 Spiegeltüren 6 Glaseinlegeböden, inkl. Schalter/Steckdose	<i>mirror cabinet, 3 mirror doors, 6 glass shelves, incl. switch/socket</i>	<i>spiegelkast, 3 spiegeldeuren, 6 glazen leggers, incl. schakelaar/stopcontact</i>	<i>armoire de toilette, 3 portes en miroir, 6 tablettes en verre, avec interrupteur/prise de courant</i>		
		Türaufteilung <i>door division deurdivisie division des portes</i>	Beleuchtung <i>lighting verlichting éclairage</i>	Leistung <i>performance prestaties performance</i>	Artikel-Nr. <i>article-no. artikel nr. article n°.</i>		
	30 / 60 / 30	LED-Aufbauleuchte, integriert <i>LED-top light, integrated LED-opbouwlamp, geïntegreerd lampe LED de surface, intégré</i>	4000 K, 11,5 W, 1260 Lumen	SLWB12		760,-	
			Dieses Produkt enthält Lichtquellen der Energieeffizienzklasse F	Korpus / carcase: 	GR55 GR25		
  	B = 78,0 cm H = 78,0 cm T = 2,8 cm	Spiegelpaneel LED Be- leuchtung, Sensorschal- ter, satiniert Helligkeit dimmbar	<i>mirror panel LED-lighting sensor switch, satined brightness dimmable</i>	<i>spiegelpaneel LED- verlichting sensorscha- kelaar, gesatineerd helderheid dimbaar</i>	<i>panneau miroir éclairage LED interrupteur tactile, satiné luminosité réglable</i>		
				Leistung <i>performance prestaties performance</i>	Artikel-Nr. <i>article-no. artikel nr. article n°.</i>		
			4000 K, 20,8 W, 2905 Lumen	SPK78		577,-	
			Dieses Produkt enthält Lichtquellen der Energieeffizienzklasse G				
  	B = 60,0 cm H = 80,0 cm T = 2,7 cm	Spiegelpaneel LED Be- leuchtung, Sensorschal- ter, satiniert Helligkeit dimmbar	<i>mirror panel LED-lighting sensor switch, satined brightness dimmable</i>	<i>spiegelpaneel LED- verlichting sensorscha- kelaar, gesatineerd helderheid dimbaar</i>	<i>panneau miroir éclairage LED interrupteur tactile, satiné luminosité réglable</i>		
				Leistung <i>performance prestaties performance</i>	Artikel-Nr. <i>article-no. artikel nr. article n°.</i>		
			4000 K, 24,5 W, 430 Lumen	SPLEK6		450,-	
			Dieses Produkt enthält Lichtquellen der Energieeffizienzklasse G				

Leuchtmittel sind nicht austauschbar / *illuminants are not interchangeable* / *verlichtingsmiddelen zijn niet uitwisselbaar* / *les illuminants ne sont pas interchangeables*

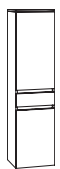

Mehrpreis Powerbox CH/FR Seite 41 / *surcharge powerbox CH/FR page 41* / *meerprijs powerbox CH/FR pag.41* / *surcoût powerbox CH/FR page 41*.

Unverbindlich empfohlene VK-Preise inkl. MwSt. / *recommended sales prices incl. VAT* / *aanbevolen verkoopprijzen inclusief BTW* / *prix de vente recommandés, TVA inclus*

OPTI premio light 2500maxus

	Maße dimension afmetingen dimensions	B = Breite / width / breedte / largeur cm H = Höhe / height / hoogte / hauteur cm T = Tiefe / depth / diepte / profondeur cm				Artikel-Nr. article-no. artikel nr. article n°.	Tür door deur porte	PG1
		DE	EN	NL	FR			
	B = 40,0 cm H = 91,2 cm T = 35,0 cm	Highboard inkl. Abdeckplatte, 1 Tür, 1 Schubkasten, 2 Glaseinlegeböden	highboard incl. top, 1 door, 1 drawer, 2 glass shelves	highboard incl. afdekplaat, 1 lade, 2 glazen leggers	highboard avec plaque de recouvrement, 1 porte, 1 tiroir, 2 tablettes en verre	GHBST4FL GHBST4FR	 	443,- 443,-
	B = 40,0 cm H = 148,8 cm T = 35,0 cm	Mittelschrank inkl. Abdeckplatte, 2 Türen, 1 Schubkasten, 3 Glaseinlegeböden	medium cabinet incl. top, 2 doors, 1 drawer, 3 glass shelves	middelgrote kast incl. afdekplaat, 2 deuren, 1 lade, 3 glazen leggers	armoire moyenne avec plaque de recouvrement, 2 portes, 1 tiroir, 3 tablettes en verre	GMTST4FL GMTST4FR	 	608,- 608,-
	B = 40,0 cm H = 178,7 cm T = 35,0 cm	Hochschrank, 2 Türen, 1 Schubkasten 3 Glaseinlegeböden	tower cabinet, 2 doors, 1 drawer, 3 glass shelves	hoge kast, 2 deuren, 1 lade, 3 glazen leggers	armoires haute, 2 portes, 1 tiroir, 3 tablettes en verre	GHTST4L GHTST4R	 	690,- 690,-

Zubehör | accessories | toebehoren | accessoires mehr ab Seite / more from page / meer van pagina / plus de la page 40

	B = 33,7 cm H = 4,3 cm T = 28,0 cm	Schubkasteneinsatz (Kunststoff) für oberen Schubkasten vom WT-Unterschrank	drawer insert (plastic) for upper drawer from the WT base cabinet	lade inzetstuk (kunststof) voor bovenste lade van de WC-basis-eenheid	bloc-tiroir (plastique) pour tiroir supérieur Coulissant de l'élément bas WT	SMBEG3		31,-
		Designsiphon	design siphon	design sifon	siphon design	DS		105,-
	B = 5,0 cm H = 1,0 cm T = 33,0 cm	Handtuchhalter 1-armig Schwarz Matt (inkl. Adapter zum Unterschrauben an die Waschtischplatte)	towel rail 1-arm black matt (incl. adapter for screwing under the washbasin)	handdoekbeugel 1-armig zwart mat (incl. adapter om onder de wastafel te schroeven)	porte-serviettes à 1 bras noir mat (y compris adaptateur à visser sous le lavabo)	HHU133		72,-

Weiteres Zubehör finden Sie ab Seite 40 / you will find further accessories from page 40 / meer accessoires vindt u vanaf pagina 40 / vous trouverez d'autres accessoires à partir de la page 40
Unverbindlich empfohlene VK-Preise inkl. MwSt. / recommended sales prices incl. VAT / aanbevolen verkoopprijzen inclusief BTW / prix de vente recommandés, TVA inclus

OPTIpremio **light** 2400modern



OPTIpremio **light** 2400modern





KWSOF8 | 80,0 x 3,0 x 45,5 cm
B x H x T | 58,0 x 11,5 x 31,0 cm



KWSOF10 | 101,0 x 3,0 x 45,5 cm
B x H x T | 58,0 x 11,5 x 31,0 cm

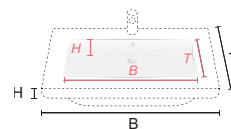

B = Breite / width / breedte / largeur
H = Höhe / height / hoogte / hauteur
T = Tiefe / depth / diepte / profondeur



Weiß Alpin Glanz
gloss white alpine
wit alpine glans
alpin blanc brillant

Griff Chrom Glanz Nr. 263/264
handle gloss chrome
greep glans chroom
poignée chrome brillant

wahlweise optional optionele optionnel

Griff Schwarz matt Struktur Nr. 237/238
handle matt black structure
greep zwarte matte structuur
poignée noire à structure mate

Front / front / front / façade

Weiß Seidenglanz
silk gloss white
wit zijdeglans
satinée blanche
BSE_

Anthrazit Matt
anthracite matt
anthraciet matt
anthracite mat
BSN_

Eiche Struktur Natur Nb.
oak structure nature finish
afwerking eiken structuur nat.
finition chêne naturel structure
BSM_

Eiche Struktur Weiß Nb.
oak structure white finish
afwerking eiken structuur wit
finition chêne blanc structure
BSL_

Eiche Struktur Braun Nb.
oak structure brown finish
afwerking eiken structuur bruin
finition chêne brun structure
BSH_

Korpus / carcass outside / corps / caisson

Weiß Matt
white matt
wit mat
blanc mat
_W (BS90) - PG 1

Korpus Aufdopplungsseiten 10 mm
carcass side panels 10 mm
corpus verdubbeldende zijden 10 mm
côtés de doublage de la caisson 10 mm

Weiß Seidenglanz
silk gloss white
wit zijdeglans
satinée blanche
E (BS86)

Anthrazit Matt
anthracite matt
anthraciet matt
anthracite mat
N (BS20)

Eiche Struktur Natur Nb.
oak structure nature finish
afwerking eiken structuur nat.
finition chêne naturel structure
M (BS55)

Eiche Struktur Weiß Nachbildung
oak structure white finish
afwerking eiken structuur wit
finition chêne blanc structur
L (BS40)

Eiche Struktur Braun Nachbildung
oak structure brown finish
afwerking eiken structuur bruin
finition chêne brun structure
H (BS70)



Maße dimension afmetingen dimensions	B = Breite / width / breedte / largeur cm H = Höhe / height / hoogte / hauteur cm T = Tiefe / depth / diepte / profondeur cm				Artikel-Nr. article-no. artikel nr. article n°.	PG1
	DE	EN	NL	FR		

	B = 80,0 cm H = 3,0 cm T = 45,5 cm	Keramik-Waschtisch inkl. Überlauf und Montage-material	ceramic washbasin incl. overflow and mounting material	keramische wastafel incl. overloop en montage-materiaal	lavabo en céramique avec trop-plein et matériel de montage	KWSOF8	237,-
---	--	--	--	---	--	--------	-------

Ohne Aufdopplungsseiten | without doubling panels | zonder verdubbeling zijden | sans doublage des côtés

	B = 75,0 cm H = 37,6 cm T = 44,0 cm	Waschtisch-Unterschrank 1 feste Blende 1 Schubkasten	washbasin base cabinet 1 fixed panel 1 drawer	wastafelonderkast 1 vaste opening 1 lade	armoire de base du lavabo 1 façade fixe 1 tiroir	WKDBS7	258,-
		B = 75,0 cm H = 48,8 cm T = 44,0 cm	Waschtisch-Unterschrank 1 Schubkasten 1 Auszug	washbasin base cabinet 1 drawer 1 pull-out	wastafelonderkast 1 lade 1 volledige uitrekelement	armoire de base du lavabo 1 tiroir 1 coulissant	WKDSA7

Mit Aufdopplungsseiten | with doubling panels | met verdubbeling zijden | avec doublage des côtés

	B = 77,0 cm H = 37,6 cm T = 44,0 cm	Waschtisch-Unterschrank inkl. Aufdopplungsseiten 10 mm 1 feste Blende 1 Schubkasten	washbasin base cabinet incl. doubling panels 10 mm 1 fixed panel 1 drawer	wastafelonderkast incl. verdubbeling van de zijden 10 mm 1 vaste opening 1 lade	armoire de base du lavabo compris doublage des côtés 10 mm 1 façade fixe 1 tiroir	WKDBS7A	330,-
		B = 77,0 cm H = 48,8 cm T = 44,0 cm	Waschtisch-Unterschrank inkl. Aufdopplungsseiten 10 mm 1 Schubkasten 1 Auszug	washbasin base cabinet incl. doubling panels 10 mm 1 drawer 1 pull-out	wastafelonderkast incl. verdubbeling van de zijden 10 mm 1 lade 1 volledige uitrekelement	armoire de base du lavabo compris doublage des côtés 10 mm 1 tiroir 1 coulissant	WKDSA7A

Ohne Aufdopplungsseiten | without doubling panels | zonder verdubbeling zijden | sans doublage des côtés

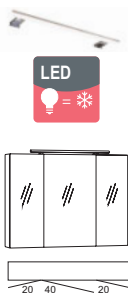
	B = 80,0 cm H = 68,2 cm T = 13,6 cm	Spiegelschrank, 3 Spiegeltüren, 6 Glaseinlegeböden, inkl. Schalter/Steckdose	mirror cabinet, 3 mirror doors, 6 glass shelves, incl. switch/ socket	spiegelkast, 3 spiegeldeuren, 6 glazen leggers, incl. schakelaar/ stopcontact	armoire de toilette, 3 portes en miroir, 6 tablettes en verre, avec interrupteur/prise de courant	Artikel-Nr. article-no. artikel nr. article n°.	SLEB8	454,-
	Türaufteilung door division deurdivisie division des portes 20 / 40 / 20		Beleuchtung lighting verlichting éclairage LED-Aufbauleuchte DE60 LED-top light DE60 LED-opbouwlamp DE60 lampe LED de surface DE60		Leistung performance prestaties performance 6000 K, 8,0 W, 870 Lumen Dieses Produkt enthält eine Lichtquelle der Energieeffizienzklasse F			

Mit Aufdopplungsseiten | with doubling panels | met verdubbeling zijden | avec doublage des côtés

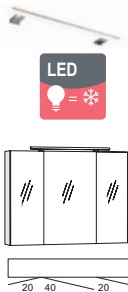
	B = 82,0 cm H = 68,2 cm T = 13,6 cm	Spiegelschrank inkl. Aufdopplungsseiten 10 mm 3 Spiegeltüren, 6 Glaseinlegeböden, inkl. Schalter/Steckdose	mirror cabinet incl. doubling panels 10 mm 3 mirror doors, 6 glass shelves, incl. switch/ socket	spiegelkast incl. verdubbeling van de zijden 10 mm 3 spiegeldeuren, 6 glazen leggers, incl. schakelaar/ stopcontact	armoire de toilette y compris doublage des côtés 10 mm, 3 portes en miroir, 6 tablettes en verre, avec interrupteur/prise de courant	Artikel-Nr. article-no. artikel nr. article n°.	SLEB8A	515,-
	Türaufteilung door division deurdivisie division des portes 20 / 40 / 20		Beleuchtung lighting verlichting éclairage LED-Aufbauleuchte DE60 LED-top light DE60 LED-opbouwlamp DE60 lampe LED de surface DE60		Leistung performance prestaties performance 6000 K, 8,0 W, 870 Lumen Dieses Produkt enthält eine Lichtquelle der Energieeffizienzklasse F			



Leuchtmittel sind nicht austauschbar / illuminants are not interchangeable / verlichtingsmiddelen zijn niet uitwisselbaar / les illuminants ne sont pas interchangeables
 Mehrpreis Powerbox CH/FR Seite 41 / surcharge powerbox CH/FR page 41 / meerprijs powerbox CH/FR pag.41 / surcoût powerbox CH/FR page 41.

Unverbindlich empfohlene VK-Preise inkl. MwSt. / recommended sales prices incl. VAT / aanbevolen verkoopprijzen inclusief BTW / prix de vente recommandés, TVA inclus

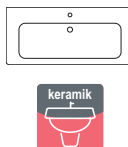
Maße dimension afmetingen dimensions	B = Breite / width / breedte / largeur cm H = Höhe / height / hoogte / hauteur cm T = Tiefe / depth / diepte / profondeur cm	Artikel-Nr. article-no. artikel nr. article n°.	PG1
---	--	--	------------

	DE	EN	NL	FR			
	B = 101,0 cm H = 3,0 cm T = 45,5 cm	Keramik-Waschtisch inkl. Überlauf und Montage-material	ceramic washbasin incl. overflow and mounting material	keramische wastafel incl. overloop en montage materiaal	lavabo en céramique avec trop-plein et matériel de montage	KWSOF10	288,-

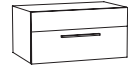
Ohne Aufdopplungsseiten | without doubling panels | zonder verdubbeling zijden | sans doublage des côtés

	B = 95,0 cm H = 37,6 cm T = 44,0 cm	Waschtisch-Unterschrank 1 feste Blende 1 Schubkasten	washbasin base cabinet 1 fixed panel 1 drawer	wastafelonderkast 1 vaste opening 1 lade	armoire de base du lavabo 1 façade fixe 1 tiroir	WKDBS9	319,-
	B = 95,0 cm H = 48,8 cm T = 44,0 cm	Waschtisch-Unterschrank 1 Schubkasten 1 Auszug	washbasin base cabinet 1 drawer 1 pull-out	wastafelonderkast 1 lade 1 volledige uittrekelement	armoire de base du lavabo 1 tiroir 1 coulissant	WKDSA9	485,-

Mit Aufdopplungsseiten | with doubling panels | met verdubbeling zijden | avec doublage des côtés

	B = 97,0 cm H = 37,6 cm T = 44,0 cm	Waschtisch-Unterschrank inkl. Aufdopplungsseiten 10 mm 1 feste Blende 1 Schubkasten	washbasin base cabinet incl. doubling panels 10 mm 1 fixed panel 1 drawer	wastafelonderkast incl. verdubbeling van de zijden 10 mm 1 vaste opening 1 lade	armoire de base du lavabo y compris doublage des côtés 10 mm 1 façade fixe 1 tiroir	WKDBS9A	381,-
	B = 97,0 cm H = 48,8 cm T = 44,0 cm	Waschtisch-Unterschrank inkl. Aufdopplungsseiten 10 mm 1 Schubkasten 1 Auszug	washbasin base cabinet incl. doubling panels 10 mm 1 drawer 1 pull-out	wastafelonderkast incl. verdubbeling van de zijden 10 mm 1 lade 1 volledige uittrekelement	armoire de base du lavabo y compris doublage des côtés 10 mm 1 tiroir 1 coulissant	WKDSA9A	556,-

Ohne Aufdopplungsseiten | without doubling panels | zonder verdubbeling zijden | sans doublage des côtés

	B = 100,0 cm H = 68,2 cm T = 13,6 cm	Spiegelschrank, 3 Spiegeltüren, 6 Glaseinlegeböden, inkl. Schalter/Steckdose	mirror cabinet, 3 mirror doors, 6 glass shelves, incl. switch/socket	spiegelkast, 3 spiegeldeuren, 6 glazen leggers, incl. schakelaar/stopcontact	armoire de toilette, 3 portes en miroir, 6 tablettes en verre, avec interrupteur/prise de courant	Artikel-Nr. article-no. artikel nr. article n°.	
		Türaufteilung door division deurdivisie division des portes	Beleuchtung lighting verlichting éclairage	Leistung performance prestaties performance		Artikel-Nr. article-no. artikel nr. article n°.	
		30 / 40 / 30	LED-Aufbauleuchte DE60 LED-top light DE60 LED-opbouwlamp DE60 lampe LED de surface DE60	6000 K, 8,0 W, 870 Lumen Dieses Produkt enthält eine Lichtquelle der Energieeffizienzklasse F		SLEB10	494,-



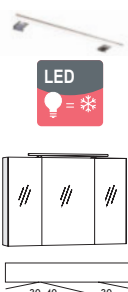



Mit Aufdopplungsseiten | with doubling panels | met verdubbeling zijden | avec doublage des côtés



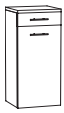



	B = 102,0 cm H = 68,2 cm T = 13,6 cm	Spiegelschrank inkl. Aufdopplungsseiten 10 mm 3 Spiegeltüren, 6 Glaseinlegeböden, inkl. Schalter/Steckdose	mirror cabinet incl. doubling panels 10 mm 3 mirror doors, 6 glass shelves, incl. switch/socket	spiegelkast incl. verdubbeling van de zijden 10 mm 3 spiegeldeuren, 6 glazen leggers, incl. schakelaar/stopcontact	armoire de toilette y compris doublage des côtés 10 mm, 3 portes en miroir, 6 tablettes en verre, avec interrupteur/prise de courant	Artikel-Nr. article-no. artikel nr. article n°.	
		Türaufteilung door division deurdivisie division des portes	Beleuchtung lighting verlichting éclairage	Leistung performance prestaties performance		Artikel-Nr. article-no. artikel nr. article n°.	
		30 / 40 / 30	LED-Aufbauleuchte DE60 LED-top light DE60 LED-opbouwlamp DE60 lampe LED de surface DE60	6000 K, 8,0 W, 870 Lumen Dieses Produkt enthält eine Lichtquelle der Energieeffizienzklasse F		SLEB10A	556,-

Leuchtmittel sind nicht austauschbar / illuminants are not interchangeable / verlichtingsmiddelen zijn niet uitwisselbaar / les illuminants ne sont pas interchangeables
 Mehrpreis Powerbox CH/FR Seite 41 / surcharge powerbox CH/FR page 41 / meerprijs powerbox CH/FR pag.41 / surcoût powerbox CH/FR page 41.
 Unverbindlich empfohlene VK-Preise inkl. MwSt. / recommended sales prices incl. VAT / aanbevolen verkoopprijzen inclusief BTW / prix de vente recommandés, TVA inclus



OPTI premio light 2400modern

Maße dimension afmetingen dimensions	B = Breite / width / breedte / largeur cm H = Höhe / height / hoogte / hauteur cm T = Tiefe / depth / diepte / profondeur cm				Artikel-Nr. article-no. artikel nr. article n°.	Tür door deur porte	PG1
	DE	EN	NL	FR			

Ohne Aufdopplungsseiten without doubling panels zander verdubbeling zijden sans doublage des côtés								
	B = 40,0 cm H = 91,2 cm T = 35,0 cm	Highboard inkl. Abdeckplatte 16 mm, 1 Tür, 1 Schubkasten, 2 Glaseinlegeböden	highboard incl. top 16 mm, 1 door, 1 drawer, 2 glass shelves	highboard incl. afdekplaat 16 mm, 1 deur, 1 lade, 2 glazen leggers	highboard avec plaque de recouvrement 16 mm, 1 porte, 1 tiroir, 2 tablettes en verre	HBST4FL HBST4FR		392,- 392,-
	B = 40,0 cm H = 148,8 cm T = 35,0 cm	Mittelschrank inkl. Abdeckplatte 16 mm, 2 Türen, 1 Schubkasten, 3 Glaseinlegeböden	medium cabinet incl. top 16 mm, 2 doors, 1 drawer, 3 glass shelves	middelgrote kast incl. afdekplaat 16 mm, 2 deuren, 1 lade, 3 glazen leggers	armoire moyenne avec plaque de recouvrement 16 mm, 2 portes, 1 tiroir, 3 tablettes en verre	MTST4FL MTST4FR		525,- 525,-
	B = 40,0 cm H = 178,7 cm T = 35,0 cm	Hochschrank, 2 Türen, 1 Schubkasten 3 Glaseinlegeböden	tower cabinet, 2 doors, 1 drawer, 3 glass shelves	hoge kast, 2 deuren, 1 lade, 3 glazen leggers	armoires haute, 2 portes, 1 tiroir, 3 tablettes en verre	HTST4L HTST4R		515,- 515,-

Mit Aufdopplungsseiten with doubling panels met verdubbeling zijden avec doublage des côtés								
	B = 42,0 cm H = 90,4 cm T = 35,0 cm	Highboard inkl. Abdeckplatte und Aufdopplungsseiten 10 mm 1 Tür, 1 Schubkasten, 2 Glaseinlegeböden	highboard incl. top and doubling panels 10 mm 1 door, 1 drawer, 2 glass shelves	highboard incl. afdekplaat en verdubbeling van de zijden 10 mm, 1 deur, 1 lade, 2 glazen leggers	highboard avec plaque de recouvrement y compris doublage des côtés 10 mm, 1 porte, 1 tiroir, 2 tablettes en verre	HBST4AL HBST4AR		464,- 464,-
	B = 42,0 cm H = 148,0 cm T = 35,0 cm	Mittelschrank inkl. Abdeckplatte und Aufdopplungsseiten 10 mm, 2 Türen, 1 Schubkasten, 3 Glaseinlegeböden	medium cabinet incl. top and doubling panels 10 mm, 2 doors, 1 drawer, 3 glass shelves	middelgrote kast incl. afdekplaat en verdubbeling van de zijden 10 mm, 2 deuren, 1 lade, 3 glazen leggers	armoire moyenne avec plaque de recouvrement y compris doublage des côtés 10 mm 2 portes, 1 tiroir, 3 tablettes en verre	MTST4AL MTST4AR		618,- 618,-
	B = 42,0 cm H = 179,7 cm T = 35,0 cm	Hochschrank inkl. Abdeckplatte mit Aufdopplungsseiten 10 mm, 2 Türen, 1 Schubkasten 3 Glaseinlegeböden	tower cabinet incl. top and doubling panels 10 mm, 2 doors, 1 drawer, 3 glass shelves	hoge kast incl. afdekplaat en verdubbeling van de zijden 10 mm 2 deuren, 1 lade, 3 glazen leggers	armoires haute avec plaque de recouvrement y compris doublage des côtés 10 mm 2 portes, 1 tiroir, 3 tablettes en verre	HTST4AL HTST4AR		701,- 701,-

Zubehör | accessories | toebehoren | accessoires mehr ab Seite / more from page / meer van pagina / plus de la page 40

	B = 33,7 cm H = 4,3 cm T = 28,0 cm	Schubkasteneinsatz (Kunststoff) für oberen Schubkasten vom WT-Unterschrank	drawer insert (plastic) for upper drawer from the WT base cabinet	lade inzetstuk (kunststof) voor bovenste lade van de W/C-basis-eenheid	bloc-tiroir (plastique) pour tiroir supérieur coulissant de l'élément bas WT	SMBEG3		31,-
	B = 57,0 cm	Spiegelschrank-Unterbauleuchte LED Beschreibung Seite 42	mirror cabinet-under-cabinet luminaire LED description accessories page 42	spiegelkast LED-armatuur voor onderkasten beschrijving zie accessoires blz. 42	armoire de toilette-luminaire d'agencement LED description, voir accessoires page 42	WTBP60VK		144,-
	B = 70,0 cm	Spiegelschrank-Unterbauleuchte LED Beschreibung Seite 42	mirror cabinet-under-cabinet luminaire LED description accessories page 42	spiegelkast LED-armatuur voor onderkasten beschrijving zie accessoires blz. 42	armoire de toilette-luminaire d'agencement LED description, voir accessoires page 42	WTB70VK		150,-

Unverbindlich empfohlene VK-Preise inkl. MwSt. / recommended sales prices incl. VAT / aanbevolen verkoopprijzen inclusief BTW / prix de vente recommandés, TVA inclus





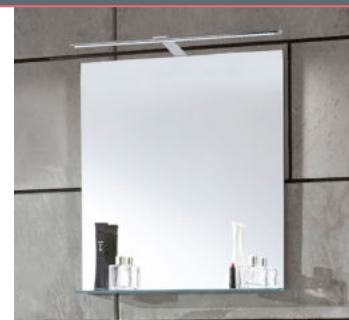

KDK

KWKOM65 | 65,0 x 6,0 x 45,0 cm
B x H x T | 54,5 x 11,5 x 39,0 cm

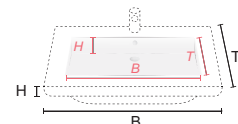

B = Breite / width / breedte / largeur
H = Höhe / height / hoogte / hauteur
T = Tiefe / depth / diepte / profondeur



KWKOM85 | 85,0 x 6,0 x 45,0 cm
B x H x T | 65,5 x 11,5 x 38,5 cm



Weiß Alpin Glanz
gloss white alpine
wit alpine glans
alpin blanc brillant



KWKOM95 | 95,0 x 6,0 x 45,0 cm
B x H x T | 65,5 x 11,5 x 38,5 cm

Griff Chrom Glanz Nr. 281 / 282
handle gloss chrome
greep glans chroom
poignée chrome brillant



Front / front / front / façade

Weiß Seidenglanz
silk gloss white
wit zijdeglans
satinée blanche
KDE_

Anthrazit Seidenglanz
silk gloss anthracite
anthraciet zijdeglans
satinée anthracite
KDA_

Eiche Struktur Natur Nb.
oak structure nature finish
afwerking eiken structuur nat.
finition chêne naturel structure
KDM_

Eiche Struktur Weiß Nb.
oak structure white finish
afwerking eiken structuur wit
finition chêne blanc structure
KDL_

Eiche Struktur Braun Nb.
oak structure brown finish
afwerking eiken structuur bruin
finition chêne brun structure
KDH_

Kastanie Graphit Nb.
graphite chestnut finish
afwerking kastanjedecor grafiet
finition châtaignier graphite
KDC_

Korpus / carcass outside / corpus / caisson

Weiß Seidenglanz
silk gloss white
wit zijdeglans
satinée blanche
_E (KD86) - PG 1











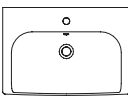

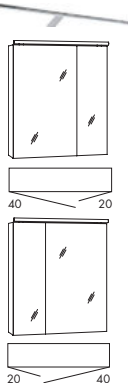
Anthrazit Seidenglanz
silk gloss anthracite
anthraciet zijdeglans
satinée anthracite
_A (KD84) - PG 1

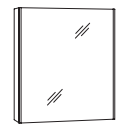
Eiche Struktur Natur Nb.
oak structure nature finish
afwerking eiken structuur nat.
finition chêne naturel structure
_M (KD55) - PG 1

Eiche Struktur Weiß Nb.
oak structure white finish
afwerking eiken structuur wit
finition chêne blanc structure
_L (KD40) - PG 1

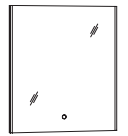
Eiche Struktur Braun Nb.
oak structure brown finish
afwerking eiken structuur bruin
finition chêne brun structure
_H (KD70) - PG 1

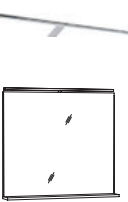







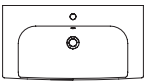

Kastanie Graphit Nb.
graphite chestnut finish
afwerking kastanjedecor grafiet
finition châtaignier graphite
_C (KD45) - PG 1

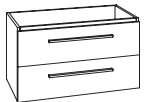
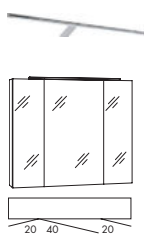
	Maße dimension afmetingen dimensions	B = Breite / width / breedte / largeur cm H = Höhe / height / hoogte / hauteur cm T = Tiefe / depth / diepte / profondeur cm				Artikel-Nr. article-no. artikel nr. article n°.	Tür door deur porte	PG1
		DE	EN	NL	FR			
	B = 65,0 cm H = 6,0 cm T = 45,0 cm 	Keramik-Waschtisch inkl. Überlauf und Montage-material	ceramic washbasin incl. overflow and mounting material	keramische wastafel incl. overloop en montage-materiaal	lavabo en céramique avec trop-plein et matériel de montage	KWKOM65		299,-
	B = 60,0 cm H = 49,5 cm T = 42,5 cm	Waschtisch-Unterschrank 2 Auszüge	washbasin base cabinet 2 pull-outs	wastafelonderkast 2 volledige uittrekelementen	armoire de base du lavabo 2 coulissants	WKKAA6		464,-
	B = 60,0 cm H = 68,2 cm T = 17,6 cm 	Spiegelschrank, 2 Spiegeltüren mit aufgeklebtem Innenspiegel, 2 Glaseinlegeböden, inkl. Schalter/Steckdose	mirror cabinet, 2 mirrored doors with glued-on interior mirror, 2 glass shelves, incl. switch/socket	spiegelkast, 2 spiegeldeuren met binnenspiegels opge-lijmd, 2 glazen legborden, incl. schakelaar/stopcontact	armoire de toilette, 2 portes à miroir avec miroir intérieur collé, 2 tablettes en verre, interrupteur/prise de courant inclus			
		Türaufteilung door division deurdivisie division des portes	Beleuchtung lighting verlichting éclairage	Leistung performance prestaties performance	Artikel-Nr. article-no. artikel nr. article n°.			
		40 / 20	LED-Aufbauleuchte AN60 LED-top light AN60	6000 K, 6,5 W, 320 Lumen	SANB6L			526,-
		20 / 40	LED-opbouwlampe AN60 lampe LED de surface AN60	Dieses Produkt enthält eine Lichtquelle der Energieeffizienzklasse G	SANB6R			526,-
	B = 60,0 cm H = 68,2 cm T = 13,6 cm 	Spiegelschrank, 1 Spiegeltür beidseitig verspiegelt, 2 Glaseinlegeböden, inkl. Schalter/Steckdose	mirror cabinet, 1 mirror door on both sides, 2 glass shelves, incl. switch/socket	spiegelkast, 1 spiegeldeur aan beide zijden, 2 glazen leggers, incl. schakelaar/stopcontact	armoire de toilette, 1 porte avec miroir des deux côtés, 2 tablettes en verre, avec interrupteur/prise de cour.			
		Türaufteilung door division deurdivisie division des portes	Beleuchtung lighting verlichting éclairage	Leistung performance prestaties performance	Artikel-Nr. article-no. artikel nr. article n°.	Tür door deur porte		
		60	Seitliche LED-Beleuchtung LED lighting on the side	6000 K, 2 x 6,3 W, 2 x 660 Lumen	SAD6L			597,-
		60	LED-verlichting aan de zijkant éclairage latéral par LED	Dieses Produkt enthält eine Lichtquelle der Energieeffizienzklasse F	SAD6R			597,-
	B = 60,0 cm H = 69,2 cm T = 2,8 cm  	Spiegelpaneel, Sensorschalter Helligkeit dimmbar	mirror panel sensor switch, brightness dimmable	spiegelpaneel, sensorschakelaar, helderheid dimbaar	panneau miroir, interrupteur du capteur, luminosité réglable			
		Beleuchtung lighting verlichting éclairage	Leistung performance prestaties performance	Artikel-Nr. article-no. artikel nr. article n°.				
			Seitliche LED-Beleuchtung LED lighting on the side LED-verlichting aan de zijkant éclairage latéral par LED	6000 K, 2 x 6,3 W, 2 x 660 Lumen Dieses Produkt enthält eine Lichtquelle der Energieeffizienzklasse F	SPBSA6			494,-
	B = 60,0 cm H = 69,2 cm T = 3,0 cm / 12,0 cm 	Spiegelpaneel mit Glasablage 60x1x12 cm, inkl. Schalter seitlich Mitte Rechts	mirror panel with glass shelf 60x1x12 cm, incl. switch lateral middle right	spiegelpaneel met glazen legger 60x1x12 cm, incl. schakelaar lateraal midden rechts	panneau miroir avec tablette en verre 60x1x12 cm, interrupteur latéral au milieu à droite inclus			
		Beleuchtung lighting verlichting éclairage	Leistung performance prestaties performance	Artikel-Nr. article-no. artikel nr. article n°.				
			LED-Aufbauleuchte AN60 LED-top light AN60 LED-opbouwlampe AN60 lampe LED de surface AN60	6000 K, 6,5 W, 320 Lumen Dieses Produkt enthält eine Lichtquelle der Energieeffizienzklasse G	SPANB6			361,-

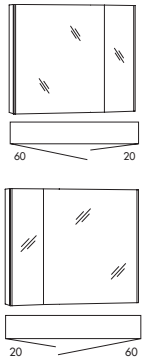

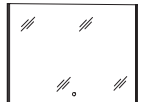





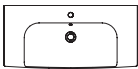

Leuchtmittel sind nicht austauschbar / illuminants are not interchangeable / verlichtingsmiddelen zijn niet uitwisselbaar / les illuminants ne sont pas interchangeables

Mehrprijs Powerbox CH/FR Seite 41 / surcharge powerbox CH/FR page 41 / meerprijs powerbox CH/FR pag.41 / surcôté powerbox CH/FR page 41.

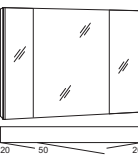
Unverbindlich empfohlene VK-Preise inkl. MwSt. / recommended sales prices incl. VAT / aanbevolen verkoopprijzen inclusief BTW / prix de vente recommandés, TVA inclus

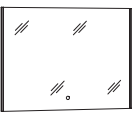
Maße dimension afmetingen dimensions		B = Breite / width / breedte / largeur cm H = Höhe / height / hoogte / hauteur cm T = Tiefe / depth / diepte / profondeur cm	Artikel-Nr. article-no. artikel nr. article n°.	PG1			
		DE	EN	NL	FR		
	B = 85,0 cm H = 6,0 cm T = 45,0 cm	Keramik-Waschtisch inkl. Überlauf und Montage-material	ceramic washbasin incl. overflow and mounting material	keramische wastafel incl. overloop en montage-materiaal	lavabo en céramique avec trop-plein et matériel de montage	KWKOM85	351,-
							
	B = 80,0 cm H = 49,5 cm T = 42,5 cm	Waschtisch-Unterschrank 2 Auszüge	washbasin base cabinet 2 pull-outs	wastafelonderkast 2 volledige uittrekelementen	armoire de base du lavabo 2 coulissants	WKKAA8	485,-
	B = 80,0 cm H = 68,2 cm T = 17,6 cm	Spiegelschrank, 3 Spiegeltüren, 6 Glaseinlegeböden, inkl. Schalter/Steckdose	mirror cabinet, 3 mirror doors, 6 glass shelves, incl. switch/socket	spiegelkast, 3 spiegeldeuren, 6 glazen leggers, incl. schakelaar/stopcontact	armoire de toilette, 3 portes en miroir, 6 tablettes en verre, avec interrupteur/prise de courant		
		Türaufteilung door division deurdivisie division des portes	Beleuchtung lighting verlichting éclairage	Leistung performance prestaties performance	Artikel-Nr. article-no. artikel nr. article n°.		
		20 / 40 / 20	LED-Aufbauleuchte AN60 LED-top light AN60 LED-opbouwlamp AN60 lampe LED de surface AN60	6000 K, 6,5 W, 320 Lumen Dieses Produkt enthält eine Lichtquelle der Energieeffizienzklasse G	SANB8	608,-	
	B = 80,0 cm H = 68,2 cm T = 13,6 cm	Spiegelschrank, 2 Spiegeltüren beidseitig verspiegelt, 2 Glaseinlegeböden, inkl. Schalter/Steckdose	mirror cabinet, 2 mirrored doors on both sides, 2 glass shelves, incl. switch/socket	spiegelkast, 2 spiegeldeuren aan beide zijden, 2 glazen legborden, incl. schakelaar/stopcontact	armoire de toilette, 1 porte avec miroir des deux côtés, 2 tablettes en verre, interrupteur/prise de courant inclus		
		Türaufteilung door division deurdivisie division des portes	Beleuchtung lighting verlichting éclairage	Leistung performance prestaties performance	Artikel-Nr. article-no. artikel nr. article n°.		
		60 / 20	Seitliche LED-Beleuchtung LED lighting on the side	6000 K, 2 x 6,3 W, 2 x 660 Lumen Dieses Produkt enthält eine Lichtquelle der Energieeffizienzklasse F	SAD8L	752,-	
		20 / 60	LED-verlichting aan de zijkant éclairage latéral par LED		SAD8R	752,-	
	B = 80,0 cm H = 69,2 cm T = 2,8 cm	Spiegelpaneel, Sensorschalter Helligkeit dimmbar	mirror panel sensor switch, brightness dimmable	spiegelpaneel, sensorschakelaar, helderheid dimbaar	panneau miroir, interrupteur du capteur, Luminosité réglable		
		Beleuchtung lighting verlichting éclairage	Leistung performance prestaties performance	Artikel-Nr. article-no. artikel nr. article n°.			
			Seitliche LED-Beleuchtung LED lighting on the side LED-verlichting aan de zijkant éclairage latéral par LED	6000 K, 2 x 6,3 W, 2 x 660 Lumen Dieses Produkt enthält eine Lichtquelle der Energieeffizienzklasse F	SPBSA8	515,-	
	B = 80,0 cm H = 69,2 cm T = 3,0 cm / 12,0 cm	Spiegelpaneel mit Glas-ablage 80x1x12 cm, inkl. Schalter seitlich Mitte Rechts	mirror panel with glass shelf 80x1x12 cm, incl. switch lateral centre right Rechts	spiegelpaneel met glazen legger 80x1x12 cm, incl. schakelaar lateraal midden rechts	panneau miroir avec tablette en verre 80x1x12 cm, y compris interrupteur latéral au centre à dr.		
		Beleuchtung lighting verlichting éclairage	Leistung performance prestaties performance	Artikel-Nr. article-no. artikel nr. article n°.			
			LED-Aufbauleuchte AN60 LED-top light AN60 LED-opbouwlamp AN60 lampe LED de surface AN60	6000 K, 6,5 W, 320 Lumen Dieses Produkt enthält eine Lichtquelle der Energieeffizienzklasse G	SPANB8	393,-	

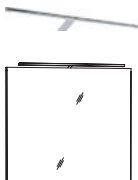





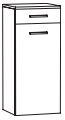

Leuchtmittel sind nicht austauschbar / illuminants are not interchangeable / verlichtingsmiddelen zijn niet uitwisselbaar / les illuminants ne sont pas interchangeables
 Mehrpreis Powerbox CH/FR Seite 41 / surcharge powerbox CH/FR page 41 / meerprijs powerbox CH/FR pag.41 / surcoût powerbox CH/FR page 41.
 Unverbindlich empfohlene VK-Preise inkl. MwSt. / recommended sales prices incl. VAT / aanbevolen verkoopprijzen inclusief BTW / prix de vente recommandés, TVA inclus

	Maße dimension afmetingen dimensions	B = Breite / width / breedte / largeur cm H = Höhe / height / hoogte / hauteur cm T = Tiefe / depth / diepte / profondeur cm				Artikel-Nr. article-no. artikel nr. article n°.	PG1			
		DE	EN	NL	FR					
	B = 95,0 cm H = 6,0 cm T = 45,0 cm 	Keramik-Waschtisch inkl. Überlauf und Montage-material	ceramic washbasin incl. overflow and mounting material	keramische wastafel incl. overloop en montage-materiaal	lavabo en céramique avec trop-plein et matériel de montage	KWKOM95	392,-			
	B = 90,0 cm H = 49,5 cm T = 42,5 cm	Waschtisch-Unterschrank 2 Auszüge	washbasin base cabinet 2 pull-outs	wastafelonderkast 2 volledige uittrekelementen	armoire de base du lavabo 2 coulissants	WKAA9	519,-			
	B = 90,0 cm H = 68,2 cm T = 17,6 cm 	Spiegelschrank, 3 Spiegeltüren, 6 Glaseinlegeböden, inkl. Schalter/Steckdose	mirror cabinet, 3 mirror doors, 6 glass shelves, incl. switch/socket	spiegelkast, 3 spiegeldeuren, 6 glazen leggers, incl. schakelaar/stopcontact	armoire de toilette, 3 portes en miroir, 6 tablettes en verre, avec interrupteur/prise de courant	Türaufteilung door division deurdivisie division des portes 20 / 50 / 20	Beleuchtung lighting verlichting éclairage LED-Aufbauleuchte AN60 LED-top light AN60 LED-opbouwlamp AN60 lampe LED de surface AN60	Leistung performance prestaties performance 6000 K, 6,5 W, 320 Lumen Dieses Produkt enthält eine Lichtquelle der Energieeffizienzklasse G	Artikel-Nr. article-no. artikel nr. article n°. SANB9	625,-
	B = 90,0 cm H = 68,2 cm T = 13,6 cm 	Spiegelschrank, 3 Spiegeltüren beidseitig verspiegelt, 6 Glaseinlegeböden, inkl. Schalter/Steckdose	mirror cabinet, 3 mirrored doors on both sides, 6 glass shelves, incl. switch/socket	spiegelkast, 3 spiegeldeuren aan beide zijden, 6 glazen legborden, incl. schakelaar/stopcontact	armoire de toilette, 3 porte avec miroir des deux côtés, 6 tablettes en verre, interrupteur/prise de courant inclus	Türaufteilung door division deurdivisie division des portes 20 / 50 / 20	Beleuchtung lighting verlichting éclairage Seitliche LED-Beleuchtung LED lighting on the side LED-verlichting aan de zijkant éclairage latéral par LED	Leistung performance prestaties performance 6000 K, 2 x 6,3 W, 2 x 660 Lumen Dieses Produkt enthält eine Lichtquelle der Energieeffizienzklasse F	Artikel-Nr. article-no. artikel nr. article n°. SAD9A	927,-
	B = 90,0 cm H = 68,2 cm T = 2,8 cm  	Spiegelpaneel, Sensorschalter Helligkeit dimmbar	mirror panel sensor switch, brightness dimmable	spiegelpaneel, sensorschakelaar, helderheid dimbaar	panneau miroir, interrupteur du capteur, Luminosité réglable	Beleuchtung lighting verlichting éclairage Seitliche LED-Beleuchtung LED lighting on the side LED-verlichting aan de zijkant éclairage latéral par LED	Leistung performance prestaties performance 6000 K, 2 x 6,3 W, 2 x 660 Lumen Dieses Produkt enthält eine Lichtquelle der Energieeffizienzklasse F	Artikel-Nr. article-no. artikel nr. article n°. SPBSA9	536,-	
	B = 90,0 cm H = 69,2 cm T = 3,0 cm / 12,0 cm 	Spiegelpaneel mit Glasablage 90x1x12 cm, inkl. Schalter seitlich Mitte Rechts	mirror panel with glass shelf 90x1x12 cm, incl. switch lateral centre right	spiegelpaneel met glazen legger 90x1x12 cm, incl. schakelaar lateraal midden rechts	panneau miroir avec tablette en verre 90x1x12 cm, y compris interrupteur latéral au centre à dr.	Beleuchtung lighting verlichting éclairage LED-Aufbauleuchte AN60 LED-top light AN60 LED-opbouwlamp AN60 lampe LED de surface AN60	Leistung performance prestaties performance 6000 K, 6,5 W, 320 Lumen Dieses Produkt enthält eine Lichtquelle der Energieeffizienzklasse G	Artikel-Nr. article-no. artikel nr. article n°. SPANB9	424,-	







Leuchtmittel sind nicht austauschbar / illuminants are not interchangeable / verlichtingsmiddelen zijn niet uitwisselbaar / les illuminants ne sont pas interchangeables

Mehrprijs Powerbox CH/FR Seite 41 / surcharge powerbox CH/FR page 41 / meerprijs powerbox CH/FR pag.41 / surcôt powerbox CH/FR page 41.

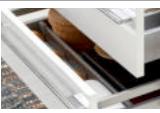
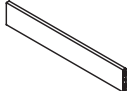
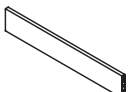
Unverbindlich empfohlene VK-Preise inkl. MwSt. / recommended sales prices incl. VAT / aanbevolen verkoopprijzen inclusief BTW / prix de vente recommandés, TVA inclus















	Maße dimension afmetingen dimensions	B = Breite / width / breedte / largeur cm H = Höhe / height / hoogte / hauteur cm T = Tiefe / depth / diepte / profondeur cm				Artikel-Nr. article-no. artikel nr. article n°.	Tür door- deur- porte	PG1
		DE	EN	NL	FR			
	B = 40,0 cm H = 91,2 cm T = 35,0 cm	Highboard inkl. Abdeckplatte, 1 Tür, 1 Schubkasten, 2 Glaseinlegeböden	highboard incl. top, 1 door, 1 drawer, 2 glass shelves	highboard incl. afdekplaat, 1 deur, 1 lade, 2 glazen leggers	highboard avec plaque de recouvrement, 1 porte, 1 tiroir, 2 tablettes en verre	HBST4FL HBST4FR	 	422,- 422,-
	B = 40,0 cm H = 148,8 cm T = 35,0 cm	Mittelschrank inkl. Abdeckplatte, 2 Türen, 1 Schubkasten, 3 Glaseinlegeböden	medium cabinet incl. top, 2 doors, 1 drawer, 3 glass shelves	middelgrote kast incl. afdekplaat, 2 deuren, 1 lade, 3 glazen leggers	armoire moyenne avec plaque de recouvrement, 2 portes, 1 tiroir, 3 tablettes en verre	MTST4FL MTST4FR	 	587,- 587,-
	B = 40,0 cm H = 178,7 cm T = 35,0 cm	Hochschrank, 2 Türen, 1 Schubkasten, 3 Glaseinlegeböden	tower cabinet, 2 doors, 1 drawer, 3 glass shelves	hoge kast, 2 deuren, 1 lade, 3 glazen leggers	armoires haute, 2 portes, 1 tiroir, 3 tablettes en verre	HTST4L HTST4R	 	618,- 618,-

Zubehör | accessories | toebehoren | accessoires

	Maße dimension afmetingen dimensions	B = Breite / width / breedte / largeur cm H = Höhe / height / hoogte / hauteur cm T = Tiefe / depth / diepte / profondeur cm				Artikel-Nr. article-no. artikel nr. article n°.	für Progr. for progr. voor progr. pour progr	
		DE	EN	NL	FR			
	H = 6,0 cm T = 1,1 cm	Inneneinteilung für Auszug 60 cm	internal subdivision for pull-out 60 cm	interne onderverdeling voor uitrekelement 60 cm	subdivision interne pour coulissant 60 cm	IEG60	2060	58,-
	H = 6,0 cm T = 1,1 cm	Inneneinteilung für Auszug 70 cm	internal subdivision for pull-out 70 cm	interne onderverdeling voor uitrekelement 70 cm	subdivision interne pour coulissant 70 cm	IEG70	2500	61,-
	H = 6,0 cm T = 1,1 cm	Inneneinteilung für Auszug 75 cm	internal subdivision for pull-out 75 cm	interne onderverdeling voor uitrekelement 75 cm	subdivision interne pour coulissant 75 cm	IEG75	2400	62,-
	H = 6,0 cm T = 1,1 cm	Inneneinteilung für Auszug 80 cm	internal subdivision for pull-out 80 cm	interne onderverdeling voor uitrekelement 80 cm	subdivision interne pour coulissant 80 cm	IEG80	2060 2510	66,-
	H = 6,0 cm T = 1,1 cm	Inneneinteilung für Auszug 90 cm	internal subdivision for pull-out 90 cm	interne onderverdeling voor uitrekelement 90 cm	subdivision interne pour coulissant 90 cm	IEG90	2060 2500	70,-
	H = 6,0 cm T = 1,1 cm	Inneneinteilung für Auszug 95 cm	internal subdivision for pull-out 95 cm	interne onderverdeling voor uitrekelement 95 cm	subdivision interne pour coulissant 95 cm	IEG95	2400	72,-
	H = 6,0 cm T = 1,1 cm	Inneneinteilung für Auszug 100 cm	internal subdivision for pull-out 100 cm	interne onderverdeling voor uitrekelement 100 cm	subdivision interne pour coulissant 100 cm	IEG100	2510	76,-
	H = 6,0 cm T = 1,1 cm	Inneneinteilung für Auszug 120 cm	internal subdivision for pull-out 120 cm	interne onderverdeling voor uitrekelement 120 cm	subdivision interne pour coulissant 120 cm	IEG120	2510	89,-

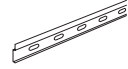

Unverbindlich empfohlene VK-Preise inkl. MwSt. / recommended sales prices incl. VAT / aanbevolen verkoopprijzen inclusief BTW / prix de vente recommandés, TVA inclus

OPTI premio light 2970

	Maße dimension afmetingen dimensions	B = Breite / width / breedte / largeur cm H = Höhe / height / hoogte / hauteur cm T = Tiefe / depth / diepte / profondeur cm				Artikel-Nr. article-no. artikel nr. article n°.		
		DE	EN	NL	FR			
	B = 5,0 cm H = 1,0 cm T = 33,0 cm	Handtuchhalter 1-armig Chrom Glanz	towel holder 1-armed gloss chrome	handdoekhouder 1-arm glanzend chroom	porte-serviettes 1 bras chrome brillant	HHF133		46,-
	B = 5,0 cm H = 1,0 cm T = 33,0 cm	Handtuchhalter 1-armig Matt Schwarz	towel holder 1-armed matt black	handdoekhouder 1-arm matzwart	porte-serviettes 1 bras noir mat	HHF133S		46,-
	B = 7,5 cm H = 4,0 cm T = 32,5/50 cm	Handtuchhalter 1-armig ausziehbar Chrom Glanz	towel holder 1-armed telescopic gloss chrome	handdoekhouder 1-arm telescopisch glanzend chroom	porte-serviettes 1 bras télescopique chrome brillant	HH133		56,-
	B = 10,5 cm H = 4,0 cm T = 32,5/50 cm	Handtuchhalter 2-armig ausziehbar Chrom Glanz	towel holder 2-armed telescopic gloss chrome	handdoekhouder 2-armige telescopisch glanzend chroom	porte-serviettes à 2 bras télescopique chrome brillant	HH233		78,-
	B = 33,7 cm H = 4,3 cm T = 33,0 cm	Schubkasteneinsatz Kunststoff für oberen Schubkasten vom Waschtisch- Unterschrank	plastic drawer insert for top drawer from washbasin base cabinet	kunststof lade-inzetstuk voor bovenste lade uit wastafelonderkast	insert de tiroir en plastique pour le tiroir supérieur du élément bas du lavabo	SMBEG3		31,-
	B = 30,9 cm H = 4,5 cm T = 28,0 cm	Schubkasteneinsatz Kunststoff für Beistell- schränke 40 cm	drawer insert plastic for side cabinets 40 cm	lade-inzetstuk kunststof voor zijkasten 40 cm	insert de tiroir en plastique pour meubles latéraux 40 cm	SEG4		34,-
		Raumsparisiphon	space-saving siphon	ruimtebesparende sifon	siphon peu encombrant	RSPAR		49,-
		Einhebel-Waschtisch- armatur, Chrom, inkl. Zugstange und Montage- material	single lever washbasin tap, chrome, incl. pull rod and fixing material	eéngreeps wastafelkraan, chroom, incl. trekstang en bevestigingsmateriaal	robinet de lavabo à levier unique, chromé, avec tige de traction et matériel de fixation	MBCA		196,-
		Einhebel-Waschtisch- armatur, Chrom, inkl. Zugstange und Montage- material	single lever washbasin tap, chrome, incl. pull rod and fixing material	eéngreeps wastafelkraan, chroom, incl. trekstang en bevestigingsmateriaal	robinet de lavabo à levier unique, chromé, avec tige de traction et matériel de fixation	MBCR		237,-
		Stand Waschtischarmatur (nur für 2500 Waschtisch Olive), inkl. Zugstange und Montage-material	stand washbasin tap (only for 2500 washbasin Olive), incl. pull rod and fixing material	staande wastafelkraan (alleen voor 2500 wastafel Olive), incl. trekstang en bevestigingsmateriaal	robinetterie de lavabo au sol (seulement pour 2500 lavabo Olive), avec tige de traction et matériel de fixation chrome	MBCE		310,-
		Chrom	chrome	chroom	chrome	MBSK		400,-
		Schwarz	black	zwart	noir			
	B = 210,0 cm	Montageschiene, inkl. Montage-material	mounting rail, incl. moun- ting material	montagerail, incl. monta- gemateriaal	rail de montage, matériel de montage inclus	MS210		46,-
		Befestigungsmaterial M10 für Keramik- und Mineral- marmor Waschtische (Bei unseren Waschtischen im Lieferumfang bereits erhalten!)	mounting set M10 for ce- ramic and mineral marble washbasins (Included with our washbasins already included!)	bevestigingsset M10 voor keramische en minerale marmere wastafels (Inbegrepen bij onze wastafels al inbegrepen!)	ensemble de fixation M10 pour lavabos en cérami- que et en marbre minéral. (Pour nos lavabos, inclus dans la livraison déjà inclus !)	MONK-4		29,-
		Steckdose / Powerbox für Spiegelschränke Ausführung Schweiz IP44 mit USB-C Stecker	socket / powerbox for mirror cabinets Switzerland version IP44 with USB-C plug	stopcontact / powerbox voor spiegelkasten Zwitserland versie IP44 met USB-C stekker	prise de courant / powerbox pour armoires de toilette version Suisse IP44 avec prise USB-C	Mehrpreis		62,-
		Steckdose / Powerbox für Spiegelschränke Ausführung Frankreich mit USB-C Stecker	socket / powerbox for mirror cabinets version France with USB-C plug	stopcontact / powerbox voor spiegelkasten versie Frankrijk met USB-C stekker	prise de courant / powerbox pour armoires de toilette version France avec prise USB-Cr	Mehrpreis		62,-

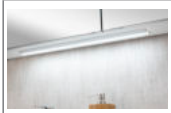
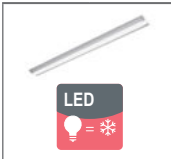
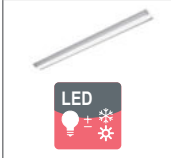
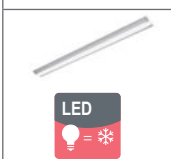

Unverbindlich empfohlene VK-Preise inkl. MwSt. / recommended sales prices incl. VAT / aanbevolen verkoopprijzen inclusief BTW / prix de vente recommandés, TVA inclus

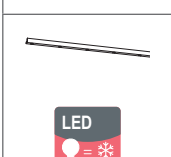
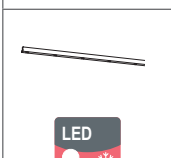
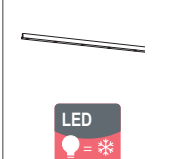
OPTI premio light 2970

	Maße dimension afmetingen dimensions	B = Breite / width / breedte / largeur cm H = Höhe / height / hoogte / hauteur cm T = Tiefe / depth / diepte / profondeur cm				Artikel-Nr. article-no. artikel nr. article n°.	für Progr. for progr. voor progr. pour progr	PG1
		DE	EN	NL	FR			
	B = 57,0 cm	Spiegelschrank- Unterbauleuchte LED Beleuchtung wird mit Konverter des Spiegel- schrank's betrieben Selbstmontage	mirror cabinet-under- cabinet luminaire LED <i>lighting is operated with converter of the mirror cabinet self-assembly</i>	spiegelkast LED-armatuur voor onderkasten <i>verlichting wordt bediend met convertor van de spiegelkast zelfassemblage</i>	armoire de toilette- luminaire d'agencement LED <i>l'éclairage est alimenté par le convertisseur de l'armoire de toilette auto-assemblage</i>	WTBP60 6000 Kelvin 3,5 Watt 350 Lumen Dieses Produkt enthält eine Lichtquelle der Energieeffizienzklasse F	72,-	
	B = 57,0 cm	Spiegelschrank- Unterbauleuchte LED regelbar Beleuchtung wird mit Konverter des Spiegel- schrank's betrieben Selbstmontage	mirror cabinet-under- cabinet luminaire LED adjustable <i>lighting is operated with converter of the mirror cabinet self-assembly</i>	spiegelkast armatuur voor onderkasten LED verstelbaar <i>verlichting wordt bediend met convertor van de spiegelkast zelfassemblage</i>	armoire de toilette- luminaire d'agencement LED réglable <i>l'éclairage est alimenté par le convertisseur de l'armoire de toilette auto-assemblage</i>	WTBPR60 2800-6500 Kelvin 3,5 Watt 350 Lumen Dieses Produkt enthält eine Lichtquelle der Energieeffizienzklasse F	72,-	
	B = 57,0 cm	Spiegelschrank- Unterbauleuchte LED inkl. Verteiler und Konverter nur für Spiegelschränke mit der Leuchte DE60 Selbstmontage	mirror cabinet-under- cabinet luminaire LED <i>incl. distributor and converter only for mirror cabinets with DE60 lamp self-assembly</i>	spiegelkast LED-armatuur voor onderkasten <i>inclusief distributeur en omvormer alleen voor spiegelkasten met DE60 lamp zelfassemblage</i>	armoire de toilette- luminaire d'agencement LED <i>y compris distributeur et Convertisseur uniquement pour les armoires de toilette avec le luminaire DE60 auto-assemblage</i>	WTBP60VK 6000 Kelvin 3,5 Watt 350 Lumen Dieses Produkt enthält eine Lichtquelle der Energieeffizienzklasse F	2400 144,-	
	B = 70,0 cm	Spiegelschrank- Unterbauleuchte LED Montage werksseitig an der unteren Spiegel- schrankrückwand; indirekte Beleuchtung für Waschtische Beleuchtung wird mit Konverter des Spiegel- schrank's betrieben	mirror cabinet-under- cabinet luminaire LED <i>factory-mounted on the lower rear wall of the mirror cabinet; indirect lighting for washbasins ghting is operated with converter of the mirror cabinet</i>	spiegelkast LED-armatuur voor onderkasten <i>in de fabriek gemonteerd op de onderste achter- wand van de spiegelkast; indirecte verlichting voor wastafels verlichting wordt bediend met convertor van de spiegelkast</i>	armoire de toilette- luminaire d'agencement LED <i>monté en usine sur la paroi arrière inférieure de l'armoire de toilette; éclairage indirect des lavabos l'éclairage est alimenté par le convertisseur de l'armoire de toilette</i>	WTB70 6000 Kelvin 3,4 Watt 252 Lumen Dieses Produkt enthält eine Lichtquelle der Energieeffizienzklasse G	82,-	
	B = 70,0 cm	Spiegelschrank- Unterbauleuchte LED Montage werksseitig an der unteren Spiegel- schrankrückwand; indirekte Beleuchtung für Waschtische incl. Verteiler und Kon- verter	mirror cabinet-under- cabinet luminaire LED <i>factory-mounted on the lower rear wall of the mirror cabinet; indirect lighting for washbasins incl. distributor and converter</i>	spiegelkast LED-armatuur voor onderkasten <i>in de fabriek gemonteerd op de onderste achter- wand van de spiegelkast; indirecte verlichting voor wastafels inclusief verdeler en omvormer</i>	armoire de toilette- luminaire d'agencement LED <i>monté en usine sur la paroi arrière inférieure de l'armoire de toilette; éclairage indirect des lavabos ldistributeur et convertis- seur inclus</i>	WTB70VK 6000 Kelvin 3,4 Watt 252 Lumen Dieses Produkt enthält eine Lichtquelle der Energieeffizienzklasse G	2400 150,-	
	B = 110,0 cm	Spiegelschrank- Unterbauleuchte LED Montage werksseitig an der unteren Spiegel- schrankrückwand; indirekte Beleuchtung für Waschtische Beleuchtung wird mit Konverter des Spiegel- schrank's betrieben	mirror cabinet-under- cabinet luminaire LED <i>factory-mounted on the lower rear wall of the mirror cabinet; indirect lighting for washbasins ghting is operated with converter of the mirror cabinet</i>	spiegelkast LED-armatuur voor onderkasten <i>in de fabriek gemonteerd op de onderste achter- wand van de spiegelkast; indirecte verlichting voor wastafels verlichting wordt bediend met convertor van de spiegelkast</i>	armoire de toilette- luminaire d'agencement LED <i>monté en usine sur la paroi arrière inférieure de l'armoire de toilette; éclairage indirect des lavabos l'éclairage est alimenté par le convertisseur de l'armoire de toilette</i>	WTB110 6000 Kelvin 5,3 Watt 396 Lumen Dieses Produkt enthält eine Lichtquelle der Energieeffizienzklasse G	107,-	
	B = 110,0 cm	Spiegelschrank- Unterbauleuchte LED Montage werksseitig an der unteren Spiegel- schrankrückwand; indirekte Beleuchtung für Waschtische incl. Verteiler und Kon- verter	mirror cabinet-under- cabinet luminaire LED <i>factory-mounted on the lower rear wall of the mirror cabinet; indirect lighting for washbasins incl. distributor and converter</i>	spiegelkast LED-armatuur voor onderkasten <i>in de fabriek gemonteerd op de onderste achter- wand van de spiegelkast; indirecte verlichting voor wastafels inclusief verdeler en omvormer</i>	armoire de toilette- luminaire d'agencement LED <i>monté en usine sur la paroi arrière inférieure de l'armoire de toilette; éclairage indirect des lavabos distributeur et convertis- seur inclus</i>	WTB110VK 6000 Kelvin 5,3 Watt 396 Lumen Dieses Produkt enthält eine Lichtquelle der Energieeffizienzklasse G	2400 175,-	

Leuchtmittel sind nicht austauschbar / illuminants are not interchangeable / verlichtingsmiddelen zijn niet uitwisselbaar / les illuminants ne sont pas interchangeables
Unverbindlich empfohlene VK-Preise inkl. MwSt. / recommended sales prices incl. VAT / aanbevolen verkoopprijzen inclusief BTW / prix de vente recommandés, TVA inclus

OPTIpremio light 2970

Maße dimension afmetingen dimensions	B = Breite / width / breedte / largeur cm H = Höhe / height / hoogte / hauteur cm T = Tiefe / depth / diepte / profondeur cm				Artikel-Nr. article-no. artikel nr. article n°.	für Progr. for progr. voor progr. pour progr	
	DE	EN	NL	FR			
 B = 60,0 cm H = 2,4 cm T = 20,0 cm	LED-Aufbauleuchte für Spiegelschrank mit LED Mini-Stecker	LED top light for mirror cabinet with LED mini plug	LED-opbouwlamp voor spiegelkast met LED mini-stekker	lampe LED de surface pour armoire de toilette avec LED mini-fiche	AW60 6000 K, 8,2 W, 1026 Lumen	2060	165,-
	B = 80,0 cm			Dieses Produkt enthält eine Lichtquelle der Energieeffizienzklasse E	AW80 6000 K, 10,8 W, 1350 Lumen	2060	185,-
	B = 90,0 cm				AW90 6000 K, 12,5 W, 1566 Lumen	2060	196,-
  B = 60,0 cm H = 2,4 cm T = 10,0 cm	LED-Aufbauleuchte für Spiegelpaneel mit LED Mini-Stecker Helligkeit dimmbar	LED top light for mirror panel with LED-mini-plug brightness dimmable	LED-opbouwlamp voor spiegelpaneel met LED-ministekker helderheid dimbaar	ampe LED de surface pour panneau miroir avec LED mini-fiche	AWP60 6000 K, 8,6 W, 1026 Lumen	2060	144,-
	B = 80,0 cm			Dieses Produkt enthält eine Lichtquelle der Energieeffizienzklasse E	AWP80 6000 K, 10,8 W, 1350 Lumen	2060	165,-
	B = 90,0 cm				AWP90 6000 K, 12,5 W, 1566 Lumen	2060	175,-

Montage| assembly

Montagehinweise

Informationen zu Montagehöhe erhalten Sie auf unserer Webseite www.optifit.de

Assembly instructions

Information on installation height is available on our website www.optifit.de.

Montage-instructies

Informatie over de montagehoogte vindt u op onze website www.optifit.de.

Instructions de montage

Vous trouverez des informations sur la hauteur d'installation sur notre site web www.optifit.de.



www.optifit.de

Beispiel / example / voorbeeld / exemple:

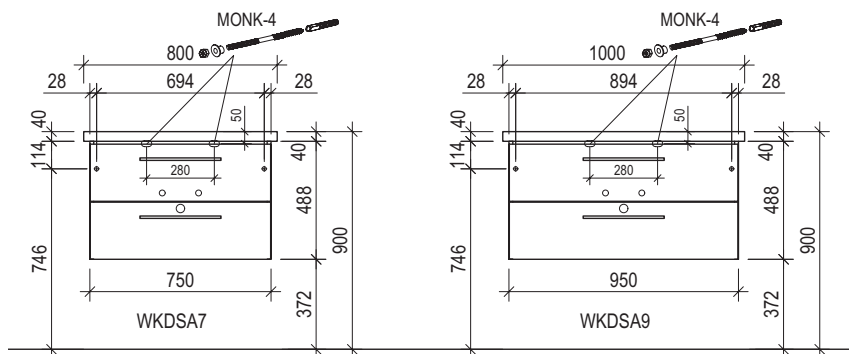

Die Montage muss durch fachkundige Personen erfolgen. Der Untergrund zur Wandbefestigung ist vor Montage zu prüfen. Bitte wählen Sie entsprechend das geeignete Montagematerial. Fehlerhafte Montagen können das Möbel beschädigen oder dessen Funktion dauerhaft beeinträchtigen. Für Sach- und Personenschäden übernehmen wir im Falle einer unsachgemäßen Montage keine Haftung.

The installation must be carried out by competent persons. The substrate for wall mounting must be checked before installation. Please choose the appropriate fixing material. Incorrect installation can damage the furniture or permanently impair its function. We accept no liability for damage to property or personal injury in the event of improper installation.

De installatie moet worden uitgevoerd door bevoegde personen. De ondergrond voor wandmontage moet voor de installatie worden gecontroleerd. Selecteer het juiste bevestigingsmateriaal. Een onjuiste installatie kan het meubilair beschadigen of de werking ervan blijvend aantasten. Wij aanvaarden geen aansprakelijkheid voor schade aan eigendommen of persoonlijk letsel in geval van onjuiste installatie.

L'installation doit être effectuée par des personnes compétentes. Le support pour le montage mural doit être vérifié avant l'installation. Veuillez sélectionner le matériel de fixation approprié. Une installation incorrecte peut endommager le mobilier ou en altérer la fonction de façon permanente. Nous déclinons toute responsabilité pour les dommages matériels ou corporels en cas d'installation incorrecte.

OPTIFIT überzeugt an allen Fronten, nicht nur im OPTIpremio Badbereich. Überzeugen Sie sich.



www.optifit.de

*OPTIFIT is convincing on all fronts, not only in the OPTIpremio bathroom area. See for yourself.
OPTIFIT overtuigt op alle fronten, niet alleen op het gebied van OPTIpremio badkamers. Kijk zelf maar.
OPTIFIT convainc sur toutes les façades, et pas seulement dans l'espace salle de bains OPTIpremio.
Laissez-vous convaincre.*



Zerlegte Küchenmöbel
*flat packed kitchen furniture
gedemonteerde keukenmeubels
meubles de cuisine démontés*



Zerlegte Badmöbel
*flat packed bathroom furniture
gedemonteerde badkamermeubels
meubles de salle de bains démontés*



Vormontierte Badmöbel OPTIguest, OPTIpremio light, prestige und plan
*assembled bathroom furniture OPTIguest, OPTIpremio light, prestige and plan
voorgemonteerd badkamermeubels OPTIguest, OPTIpremio light, prestige en plan
meubles de salle de bains assemblés OPTIguest, OPTIpremio light, prestige et plan*



® Eine Marke der
JAKA-BKL GmbH | Jaka-Str. 3 | 32351 Stemwede
Tel. +49 (0) 5773 / 88-0
www.optifit.de | info@jaka-bkl.de | 05.23

Technische Änderungen und Druckfehler vorbehalten, alle Maße sind ca. Angaben, Farben können aus drucktechnischen Gründen abweichen.

Subject to technical changes and printing errors, all dimensions are approximate, colours may vary for printing reasons.

Onder voorbehoud van technische wijzigingen en drukfouten zijn alle afmetingen bij benadering, de kleuren kunnen om druktechnische redenen afwijken.

Sous réserve de modifications techniques et d'erreurs d'impression, toutes les dimensions sont approximatives, les couleurs peuvent varier pour des raisons d'impression.

Ihr Händler / your dealer / uw dealer / votre revendeur